



K3 Service Part List

Ver 1.9



Global SS Division



65 page

OSSTEM IMPLANT

Version	Description	Date	Remark
1.0	Initial Release	2024.05.30	-
1.1	Change the part code for 'AIR FILTER/REGULATOR' Add the part code 'K3 UNIT BOLT KIT (해외)' to Unit Ass'y	2024.06.03	Unit – B10, B18
1.2	Change the part code for 'K3 SUCTION FILTER CAP' Add the part codes for ' K3-light POLE(Mount) 540mm' Add the part codes for ' K3-light POLE(CART) 703mm' Add the part codes for ' MONITOR ARM PAKING'	2024.06.07	Unit – B1 Light Arm – F1
1.3	The guide for the detailed specification of the LED light main PCB	2024.06.24	Light – E2
1.4	Add the part codes for 'SUCTION TUBING L (일본향) / MEDIFLEX VOR' Add the part codes for 'SUCTION TUBING S (일본향) / MEDIFLEX VOR'	2024.06.26	Unit – B2, B3
1.5	Add the part codes for 'SUCTION O-ring' Add the part codes for 'ASSIST TABLE BOTTOM COVER (확장형) / ASSIST TABLE TOP COVER (확장형)'	2024.08.01	Unit – B4 Assit Table – C1
1.6	Change the part code for 'K3 Headrest Seat Ass'y (1관절)'	2024.08.13	Chair – A6
1.7	Add the part code for 'V124A-5MOU'	2024.09.03	Table – D1
1.8	Change the part code for 'K3 Solenoid Valve'	2024.09.26	Unit – B9, B10
1.9	Change the part code and part name for 'YK3LI0327' K3 LED LIGHT SWITCH POLE COVER	2025.01.22	Light – E11



Category	Ass'y Name	Page
A	Chair	p.4
B	Unit	p.13
C	Assist Table	p.32
D	Dr. Table	p.35
E	Light	p.43
F	Light Arm	p.47
G	Hanaro Console	p.49
H	Monitor Arm	p.52
I	Balance Arm	p.54
J	Foot Pedal	p.57
K	Stool	p.61

(A) Chair

A. CHAIR





A. Chair – A1

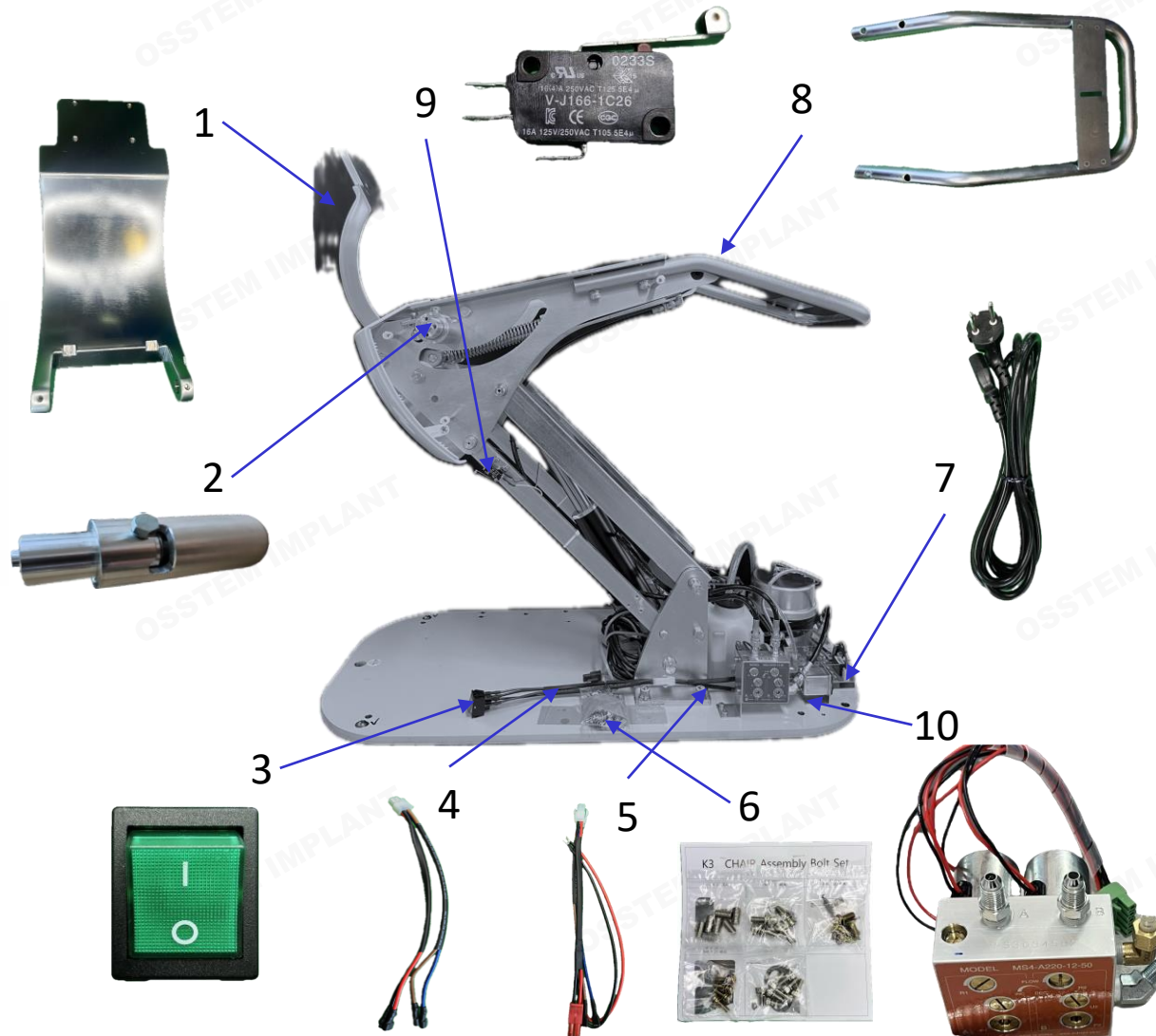

Index	Part code	Part name	Remark
1	YK3BCSP02	BACKREST SUPPORT	
2	YK3ARSR01	ARMREST SHAFT RIGHT ASS'Y	
3	YK2MISW01	MAIN SWITCH (15A,250V)	
4	YK3VASW01	K3 220VAC SWITCH	
5	YK3NSFT01	K3 NOISE FILTER	
6	YK3CHA014	K3 CHAIR ASS'Y BOLT SET (Export)	
7	YK3PWVA01	K3 POWER 220VAC	
8	YK3BSPP01	BASE SEAT PIPE ASS'Y	
9	YK2MRST01	CHAIR LIMIT SWITCH (MICRO SWITCH)	
10-1	YK2SLVV02	SOLENOID VALVE	For 220V
10-2	YK2SLVV01	SOLENOID VALVE	China only
10-3	YK3ISNV02	SOLENOID VALVE (SVM-MS4-A110-12-50) 110V	For 110V



A. Chair – A2

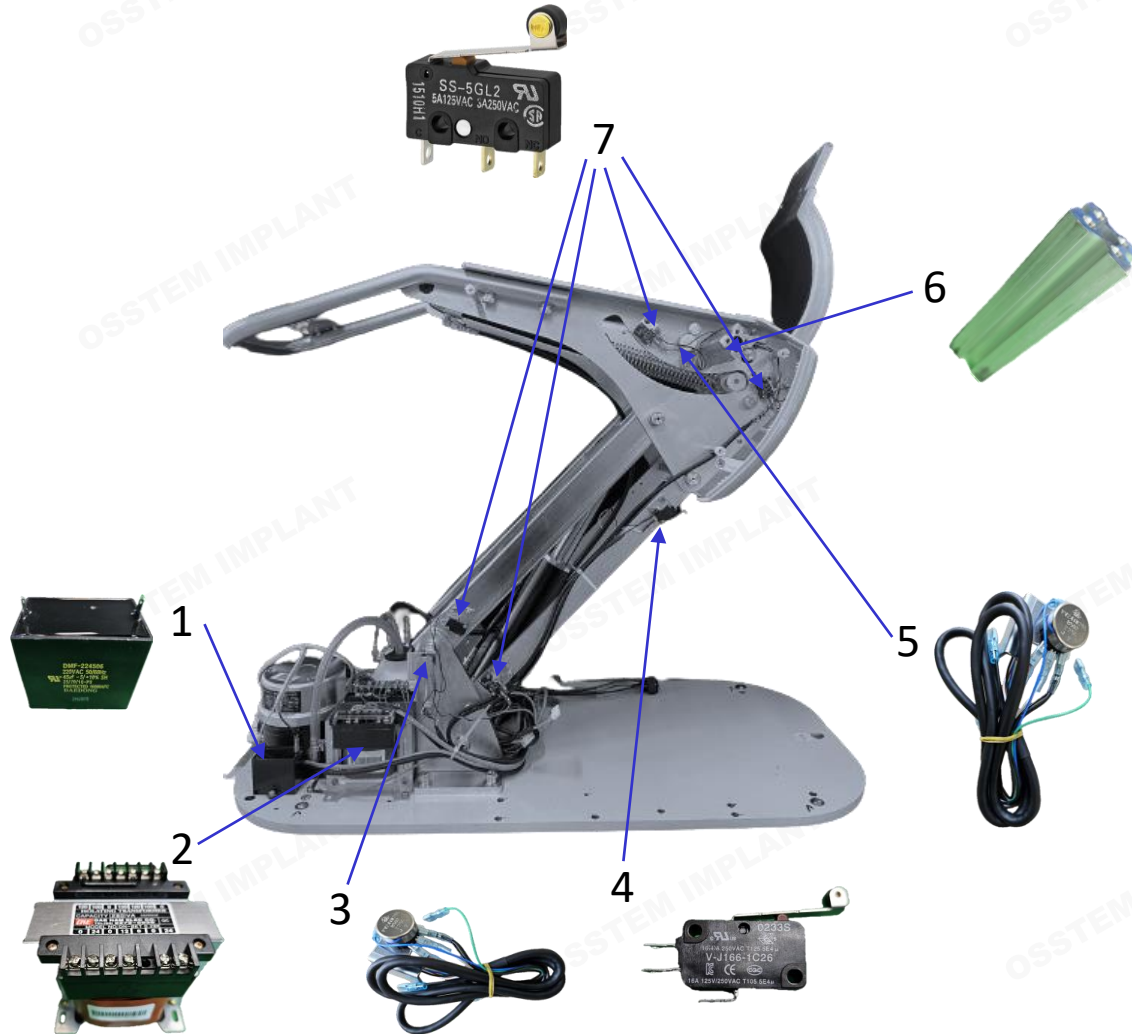

Index	Part code	Part name	Remark
1-1	YK3ICAP01	CAPACITOR (DAEDONG-45UF) 450VAC	220V
1-2	YK3ICAB01	CAPACITOR (DAEDONG-45UF) 220VAS	110V
2-1	YK3MNTR01	K3 MAIN TRANS 0.27K	For Korea
2-2	YK3MNTR11	MAIN TRANS (DN-BET 0.28K)	For Overseas
2-3	YK3SLVT01	TRANS BETA-0.38K	For Water seperator
3	YK3MNCV01	K3 MAIN Chair VR	
4	YK2MRST01	Chair Limit Switch (MICRO SWITCH)	
5	YK3MNBV01	K3 MAIN BREST VR	
6	YK3ARSL01	ARMREST SHAFT LEFT	
7	YK2MSBK01	M/S (BLACK) SS-5GL2	



A. Chair – A3

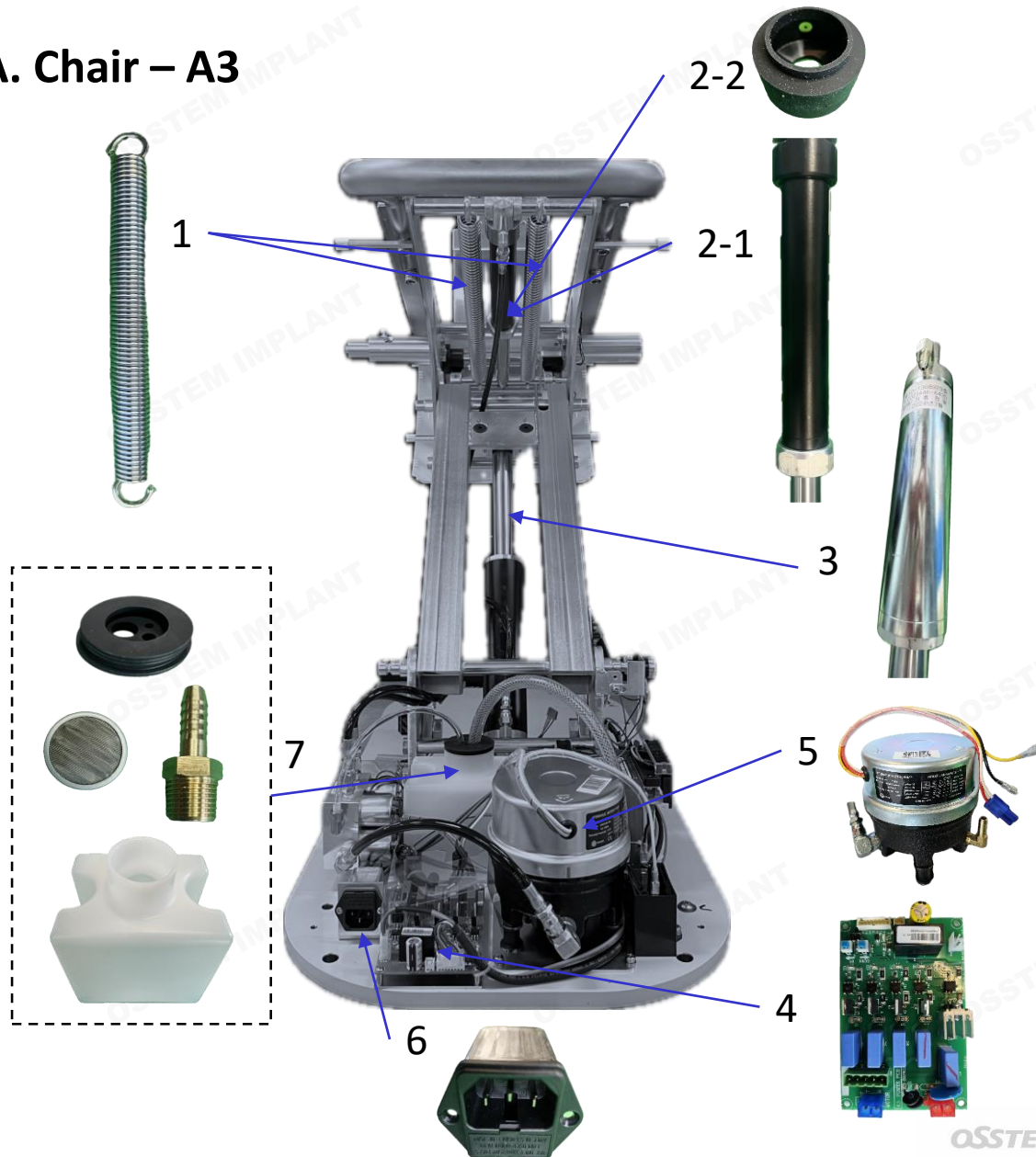

Index	Part code	Part name	Remark
1	YK3BCSR01	BACKREST SPRING	2EA
2-1	YK3BCCA01	K3 BACKREST CYLINDER ASS'Y	
2-2	YK3CPCH01	BACKREST CYLINDER RUBBER	
3	YK3CPSC01	K3 CHAIR CYLINDER	
4	YK3PWPC02	POWER PCB	
5-1	YK2MTPM02	K3 MOTOR SUB ASS'Y 220V	For 220V
5-2	YK2MTPM01	K3 MOTOR SUB ASS'Y	China only
5-3	YK3IMTP02	MOTOR PUMP (MHM-PST-5L-P-V1) 110V	For 110V
6	YK3INSF01	NOISE FILTER	
7-1	YK2OBTL02	OIL BOTTLE (NEW)	
7-2	YOBNP01	OIL BOTTLE NIPPLE	
7-3	YK2FTPK02	PLATE FILTER	
7-4	YK2OBCP02	RUBBER CAP	

A. Chair – A4

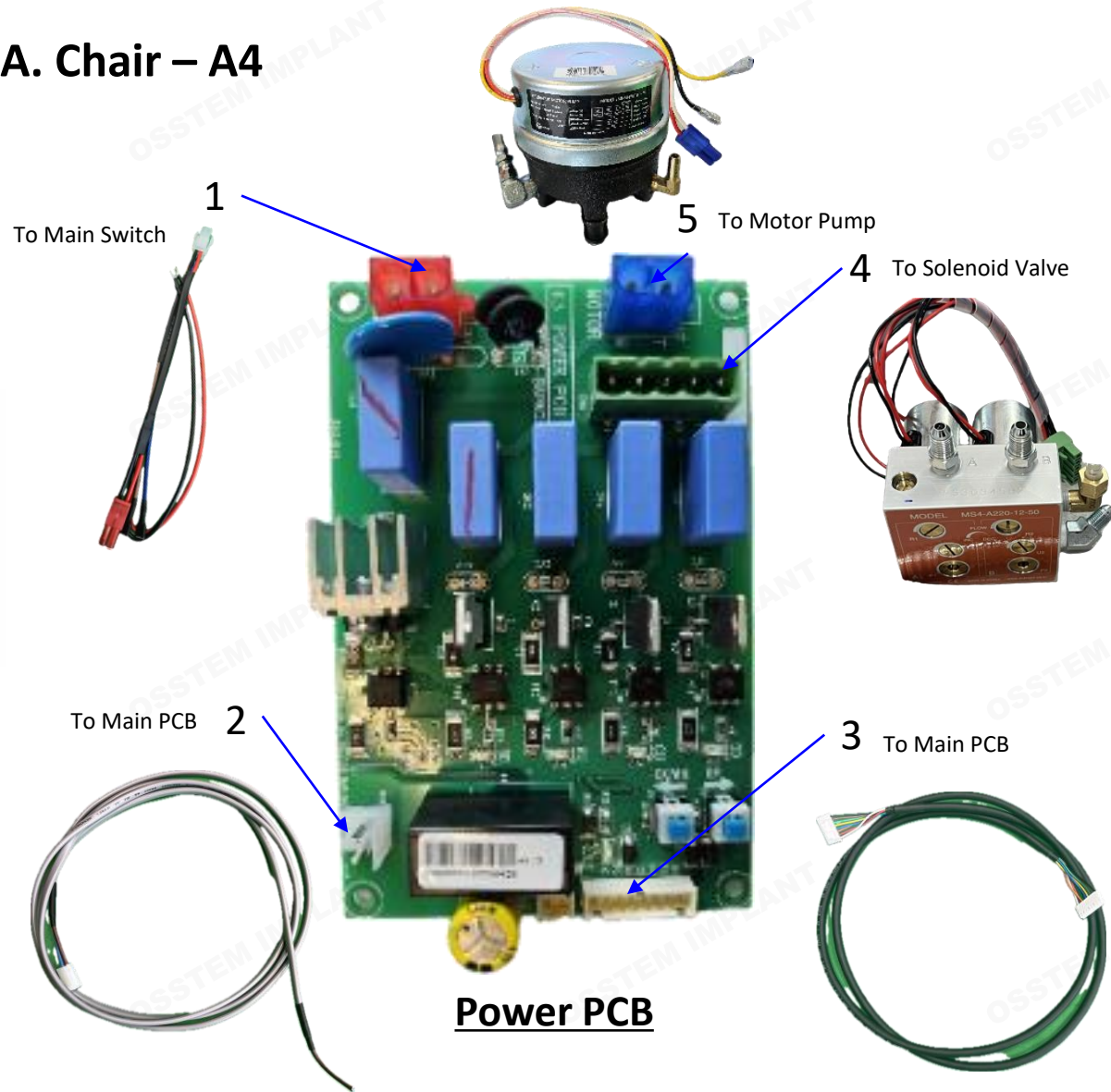

Index	Part code	Part name	Remark
1	YK3NSFT01	K3 NOISE FILTER	
2	YKEPWCV01	K3 POWER CVS	
3	YK3PWDT01	K3 POWER DATA	
4-1	YK2SLVV02	SOLENOID VALVE	For 220V
4-2	YK2SLVV01	SOLENOID VALVE	China only
4-3	YK3ISNV02	SOLENOID VALVE (SVM-MS4-A110-12-50) 110V	For 110V
5-1	YK2MTPM02	K3 MOTOR SUB ASS'Y 220V	For 220V
5-2	YK2MTPM01	K3 MOTOR SUB ASS'Y	China only
5-3	YK3IMTP02	MOTOR PUMP (MHM-PST-5L-P-V1) 110V	For 110V

A. Chair – A5



Index	Part code	Part name	Remark
1-1	YK3BABC01	BASE BACK COVER	
1-2	YK3BABC11	BASE BACK COVER (extended)	extended
2	YK3CTBC01	CENTERPIECE BACK COVER	
3	YK3CTRC01	CENTERPIECE RIGHT COVER	
4-1	YK3MTCV01	MOTOR COVER	
4-2	YK3MTCV11	MOTOR COVER (extended)	extended
5-1	YK3BAFC01	BASE FRONT COVER	
5-2	YK3BAFC11	BASE FRONT COVER (extended)	extended
6	YK3CTLC01	CENTERPIECE LEFT COVER	
7	YK3UCNC01	UPPER CHANNEL COVER	
8	YK3LCCV01	LOW CHANNEL COVER	
9	YK3ARRT01	ARMREST (right)	
10	YK3ARLF01	ARMREST (left)	
11	YK3ARCA01	ARMREST CAP	

A. Chair – A6

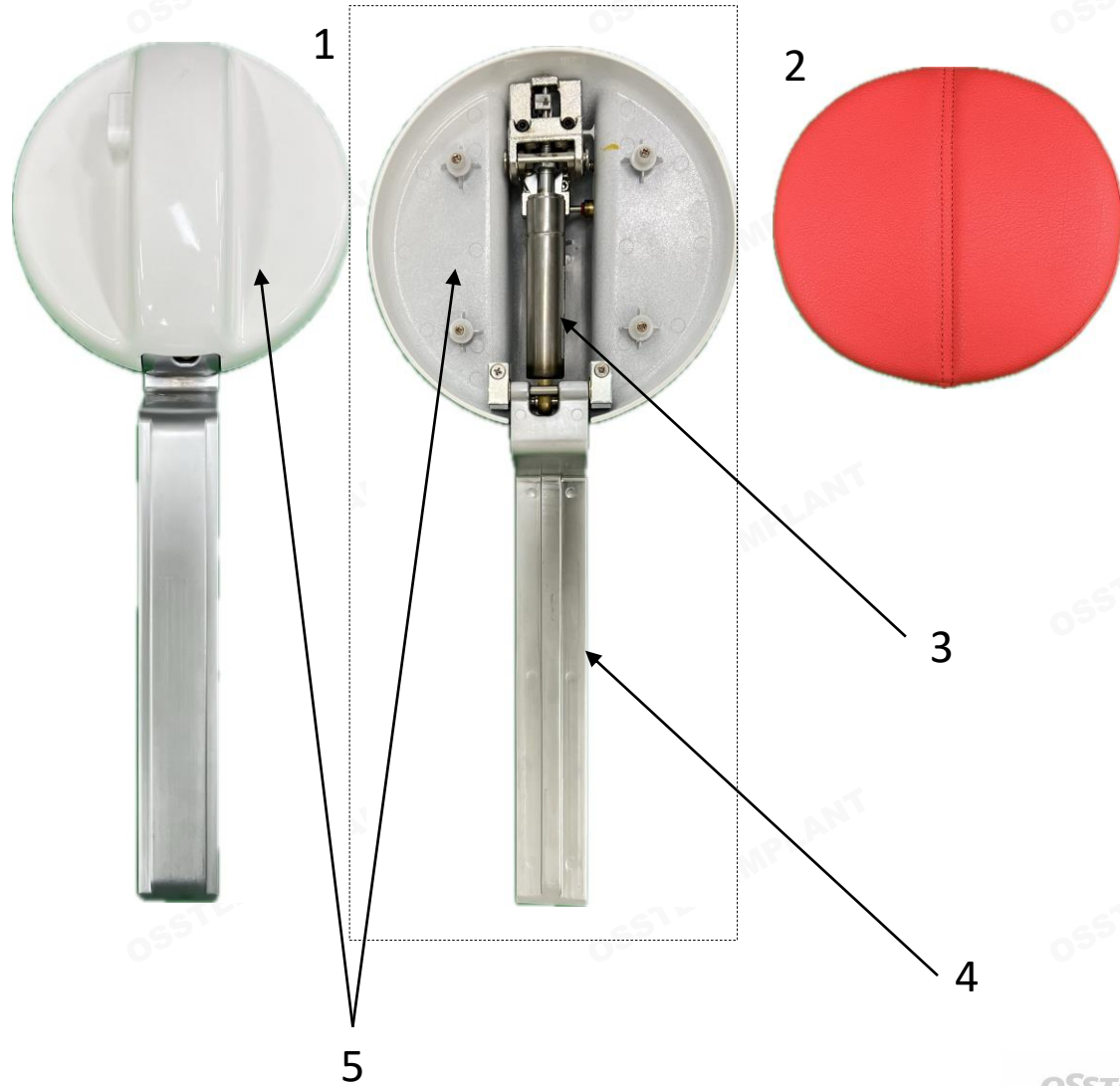

Index	Part code	Part name	Remark
1	K3HB	Headrest ass'y	
2	YHRSA01	K3 HEADREST SEAT ASS'Y (1관절)	1 Joint type Select color
3	YK3HDGC01	HEADREST GAS CYLINDER	
4	YK3SLBA01	SLIDE BAR 1관절	1 Joint type
5	YK3HRCV01	HEADREST COVER	

A. Chair – A7

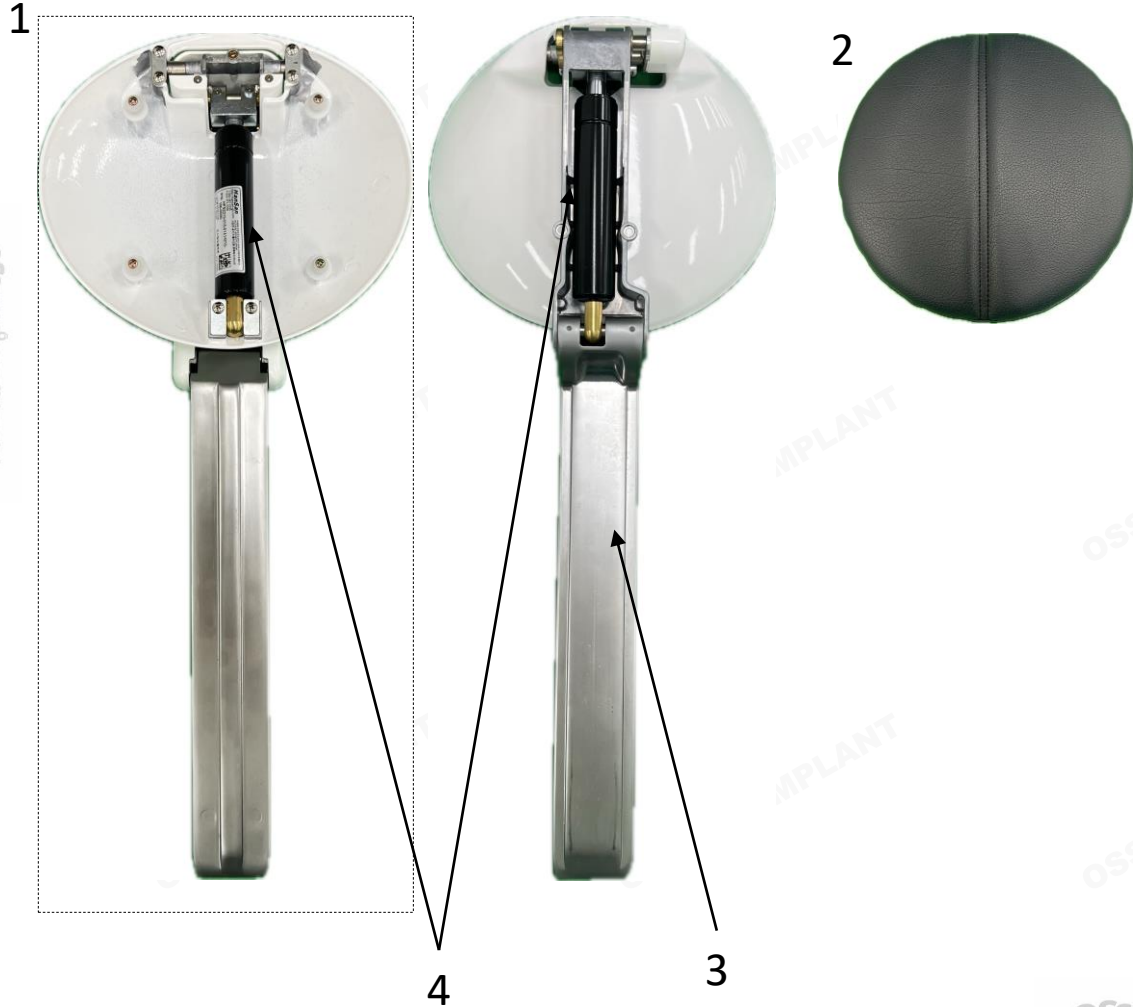

Index	Part code	Part name	Remark
1	K3HR	Headrest ass'y	
2	YKRSA03	K3 HEADREST SEAT ASS'Y (NEW) 2관절	2 Joint type Select color
3	YPDI-00003	SLIDE BAR 2관절	2 Joint type
4	YK3HDGC01	HEADREST GAS CYLINDER	

A. Chair – A8

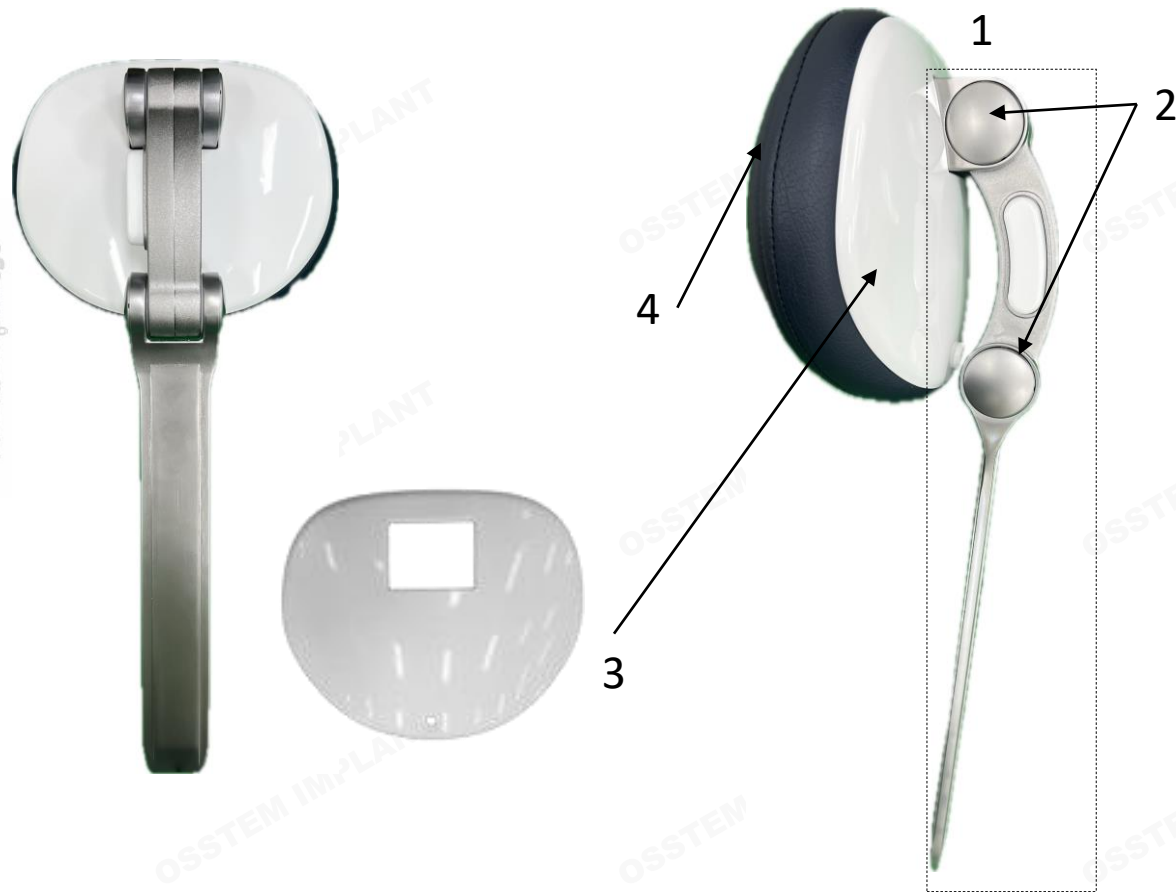

Index	Part code	Part name	Remark
1	K5-HR0000	K5 HEADREST ASS'Y	
2	YK5-HR0007	2HR_CAP	
3	YK5-HR0201	2HR_BACK_COVER	
4-1	YK5-SE0300	K5 SINGLE HR SEAT ASS'Y	
4-2	YK5-SE0600	K5 DOUBLE HR SEAT ASS'Y	

(B) Unit



B. Unit – B1



Index	Part code	Part name	Remark
1	YK3SNFP01	SUCTION FILTER CAP	
2	YORINGAN026	O-RINGP-AN-026	
3	YK3SFIR01	SUCTION FILTER INNER	
4	YK3UBCR02	UNIT BASE COVER R	
5	YK3COCB01	CONCENT CAP B	
6	YK3CPPE01	CUP PLATE	
7-1	YK3SRCR01DB	SPITTOON TOP COVER (Dark Blue)	
7-2	YK3SRCR01BR	SPITTOON TOP COVER (Brown)	
7-3	YK3SRCR01OR	SPITTOON TOP COVER (Orange)	
7-4	YK3SRCR01RE	SPITTOON TOP COVER (Red)	
7-5	YK3SRCR01GR	SPITTOON TOP COVER (Green)	
7-6	YK3SRCR01IV	SPITTOON TOP COVER (Ivory)	
7-7	YK3SRCR01DV	SPITTOON TOP COVER (Dark Violet)	
7-8	YK3SRCR01BL	SPITTOON TOP COVER (Blue)	
7-9	YK3SRCR01GD	SPITTOON TOP COVER (Gold)	

B. Unit – B2



Ass'y



Index	Part code	Part name	Remark
1-1	YK2STHD01	SUCTION HOLDER (HVE)	
1-2	YK2STHD02	SUCTION HOLDER (대) NIPPLE SIZE UP	From Mar.2020
2	YSLBO01	VITON AN013	O-ring
3-1	YMDM-YK2STHD01-2	SYRINGE PIN(大) 내수	
3-2	YMDM-YK2STHD02-2	SYRINGE PIN(大) 수출	From Mar.2020
4	YSHLC01	석션 홀더 레버 (대)	Suction Holder Lever (L)
5-1	YMDM-YK2STHD01-3	SYRINGE CONNECTOR(大) 내수	
5-2	YMDM-YK2STHD02-3	SYRINGE CONNECTOR(大) 수출	From Mar.2020
6	YSHLR01	SUCTION HOLDER RUBBER	
7-1	YK3SUTL01	SUCTION TUBING L (9.5mm x 50m)	
7-2	YK3SUTL11	SUCTION TUBING L (9.5mm x 2m)	
7-3	YK3SUTL04	SUCTION TUBING L (11.5mm x 50m)	From Mar.2020
7-4	YK3SUTL14	SUCTION TUBING L (11.5mm x 2m)	From Mar.2020
7-5	YCM-TU3001	Suction Tubing L (일본향) / MEDIFLEX VOR	Japan only(1m)
7-6	YCM-TU3003	SUCTION TUBING L (일본향) / MEDIFLEX VOR (L	Japan only(2m)

B. Unit – B3



Index	Part code	Part name	Remark
8-1	YK2SLET01	SUCTION HOLDER (소) (SALLVA EJACTOR) ø4.5	
8-2	YK2SLET02	SALLVA EJACTOR (소) NIPPLE SIZE UPø6.5	From Mar.2020
9	YSSBO01	SILICON AN-010S	O-ring
10-1	YMDM-YK2SLET01-2	SYRINGE PIN(小) 내수	
10-2	YMDM-YK2SLET02-2	SYRINGE PIN(小) 수출	From Mar.2020
11	YSHSC01	석션홀더레버(소)	Suction Holder Lever (s)
12-1	YMDM-YK2SLET01-3	SYRINGE CONNECTOR(小) 내수	
12-2	YMDM-YK2SLET02-3	SYRINGE CONNECTOR(小) 수출	From Mar.2020
13	YSHLR01	SUCTION HOLDER RUBBER	
14-1	YK3SUTS01	SUCTION TUBING S (4.5mm x 200M)	
14-2	YK3SUTS11	SUCTION TUBING S (4.5MM X 1.5M)	
14-3	YK3SUTS03	SUCTION TUBING S (7MM X 200M)	From Mar.2020
14-4	YK3SUTS13	SUCTION TUBING S (6.5MM X 1.5M)	From Mar.2020
14-5	YCM-TU3002	Suction Tubing S (일본향) / MEDIFLEX VOR	Japan only(1m)
14-6	YCM-TU3004	SUCTION TUBING S (일본향) / MEDIFLEX VOR (Japan only(2m)

B. Unit – B4

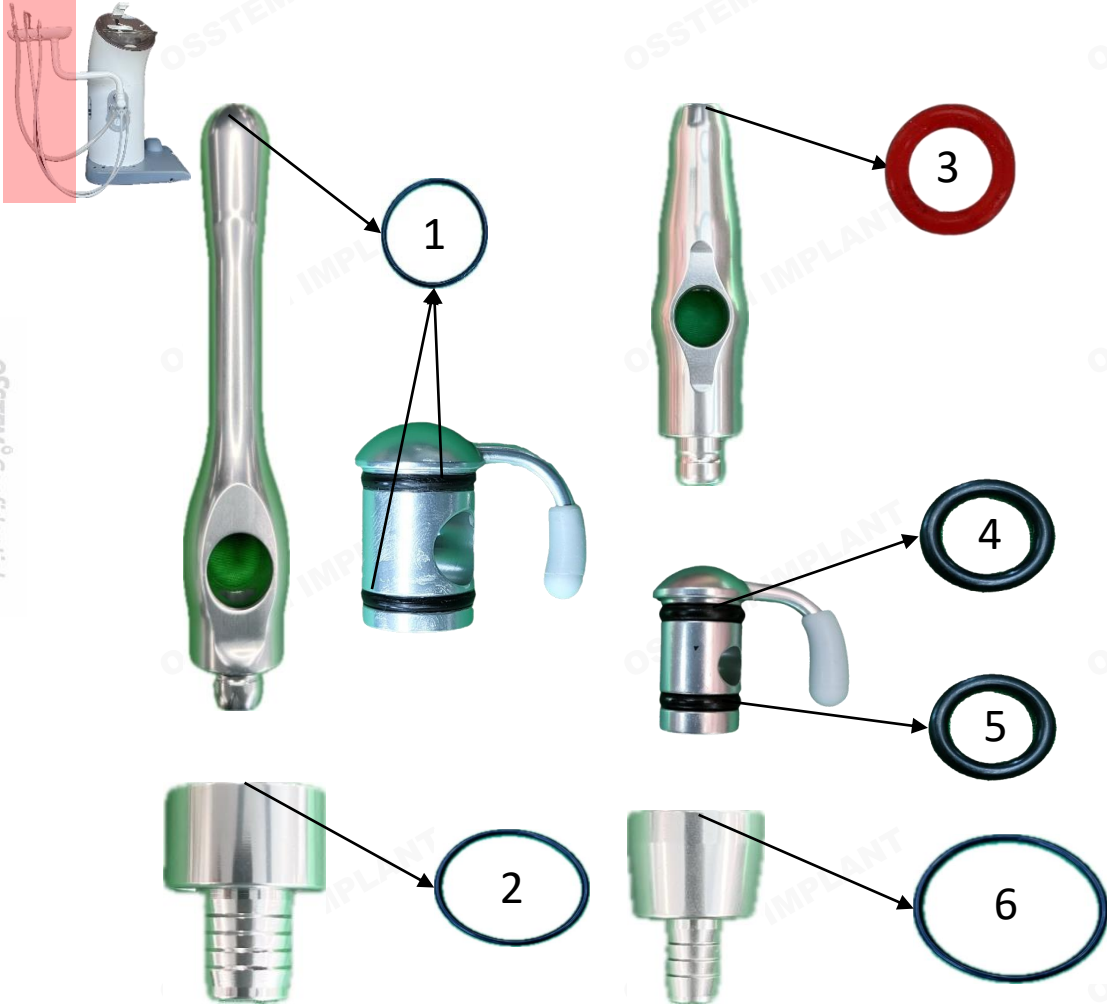

Index	Part code	Part name	Remark
1	YSLBO01	VITON AN013	
2	YSLNO01	VITON AN-014F	
3	YSSBO01	SILICON AN-010S	
4	YSSHO01	VITON AN-009F	
5	YSSLO01	VITON AN010	
6	YSSNO01	VITON AN-012F	



Remark

B. Unit – B5



Index	Part code	Part name	Remark
1	YK3MNLV01	K3 MAIN LEVEL VR	
2	YK3KNOB01	UNITKNOB(F-1A)	
3	YK3MNLV01	K3 MAIN LEVEL VR	Including No.1 part
4	YK3UEPB02	USB Extension PCB1.2v	
5	YK3BCCP01	BASE COVER CAP	

B. Unit – B6



Index	Part code	Part name	Remark
1	YK3INSF01	NOISE FILTER (SCHURTER-5220.1023.3)	
2	YK3CSET01	콘센트220V 2구세로알맹이 신동	Power outlet 220V
3	YK3CTCA01	CONCENT CAP A	
4	K3WS	CLEAN WATER SYSTEM ASS'Y	
5	YK3WTBR01	HOUSING ARM COVER RUBBER	
6	YK3BCCV01	BACK COVER CAP	

B. Unit – B7

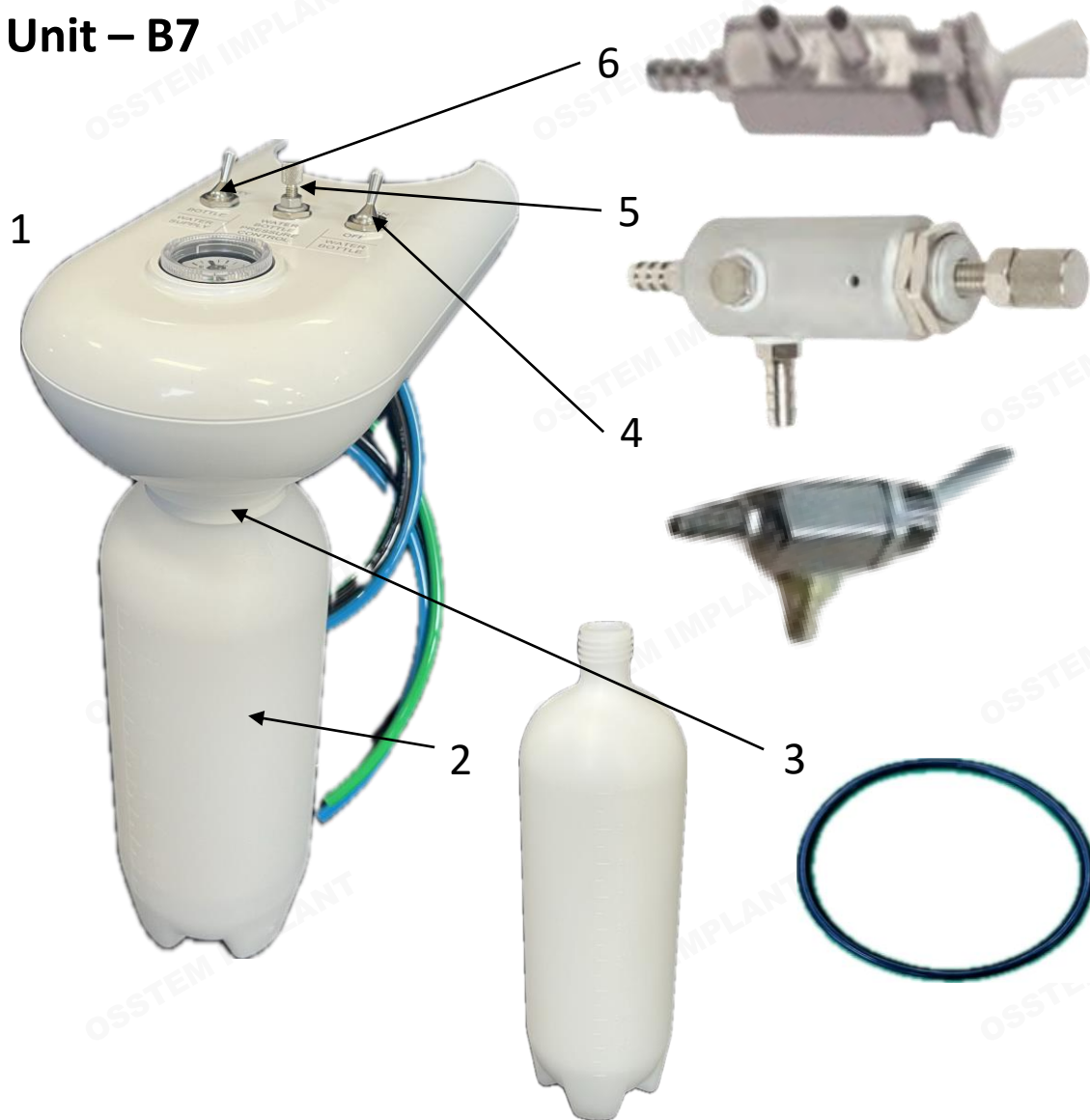

Index	Part code	Part name	Remark
1	K3WS	CLEAN WATER SYSTEM ASS'Y	
2	YK3WTWB02	WATER BOTTLE (NEW)	
3	YK3WTUR01	URETHANE RING	
4	YKM-2VER	YKM-2VER (소형 메카니칼) 2WAY V/V	
5	YKAR105-M5	KAR105-M5 (미니츄어 레귤레이터) AIR REGULATOR	
6	YKM-3VER	YKM-3VER (소형 메카니칼) 3WAY V/V	



B. Unit – B8



Index	Part code	Part name	Remark
1	YK3LAMC01	LARGE ARM CAP	
2	YK3ACAY01	K3 AUTO CUP ASS'Y	
3	YK3PEGE02	PIPE GUIDE (NEW)	
4	YK3SPTN02	SPITTOON (NEW)	Select Opaque
5	YK3SNFC01	SPITTOON FILTER COVER	
6	YK3SNFR01	SPITTOON FILTER	
7	YK3SNST01	SPITTOON SOCKET	
8	YORINGG55	O-RING G55 (소켓오링)	Socket O-ring
9	YK3SNLR01	SPITTOON LOCKER	
10	YK3SNNE01	SPITTOON NOZZLE	
11	YORINGP8	O-RING P8 (노즐오링)	Nozzle O-ring
12	YK3ASPB02	Auto Sensor PCB 1.2v	
13	YK3SSCR01	SPITTOON SENSOR COVER	

B. Unit – B9

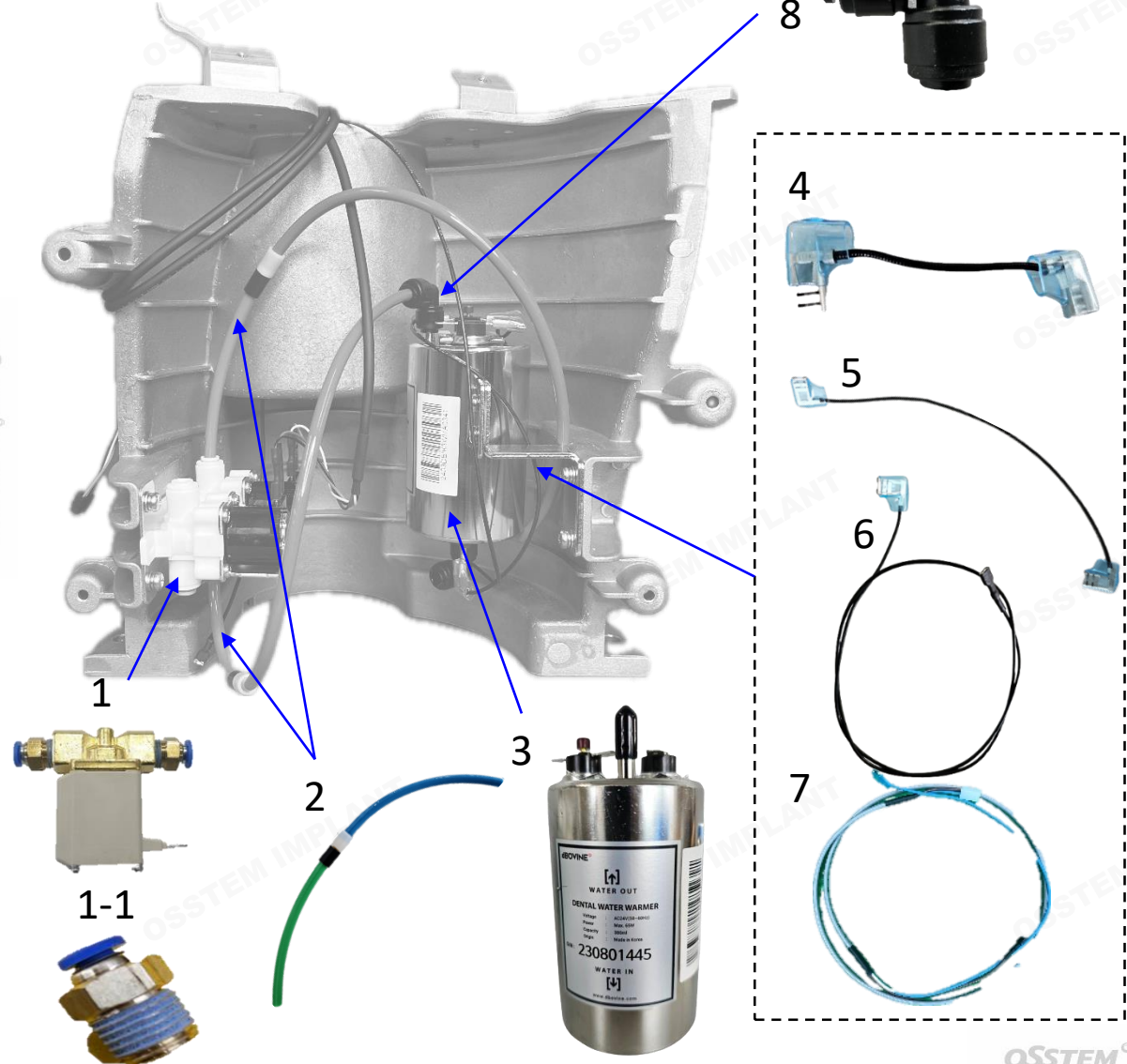

Index	Part code	Part name	Remark
1	YK22WSV04	SMC VX212DYXB	
1-1	YPC0602	SA-PC-06-02(상아)	
1-2 <i>old</i>	YK22WSV03	HSV-FF-TER180-24V	
2	YK3WSVN12	WATER SOL. V/V NIPPLE (INCH) ASS'Y	
3	YK2WRME01	WARMER	
4	YK3BMTA01	K3 BIMETAL 1	
5	YK3WRT201	K3 WARMER TERMINAL 200	
6	YK3WRT651	K3 WARMER TERMINAL 650	
7	YK3WPSH01	K3 WARMER POWER SWITCH	
8	YHUL0606	HUL-0606	
1-2 <i>old</i>			



B. Unit – B10

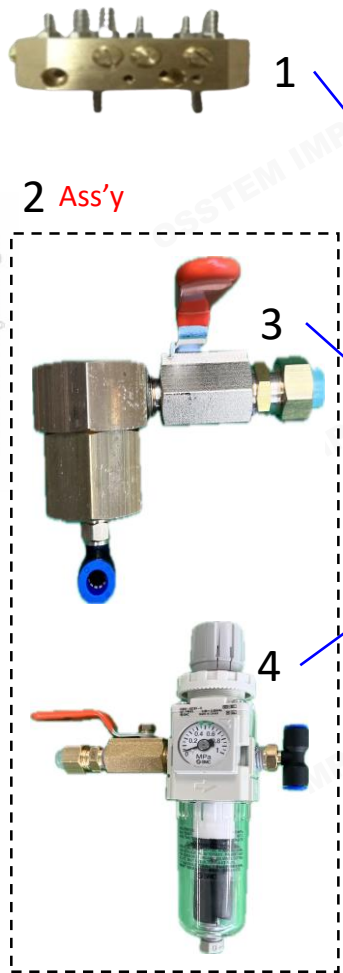

Index	Part code	Part name	Remark
1	YK3CBAY01	K3 CONTROL BLOCK ASS'Y	
2	YK3WFAY03	JUNCTION - WATER FILTER REGULATOR ASS'Y	
3	YK3WFAY01	JUNCTION - WATER FILTER	
4	YK5-JU0500	AIR REGULATOR ASS'Y	
5	YK3PSRV01	PRV-FFA140-2.5K / TRADE NAME: 3A1141A250	
6	YK22WSV04	SMC VX212DYXB	
6-1	YPC0602	SA-PC-06-02(상아)	
6-2	YK22WSV03	HSV-FF-TER180-24V	

B. Unit – B11

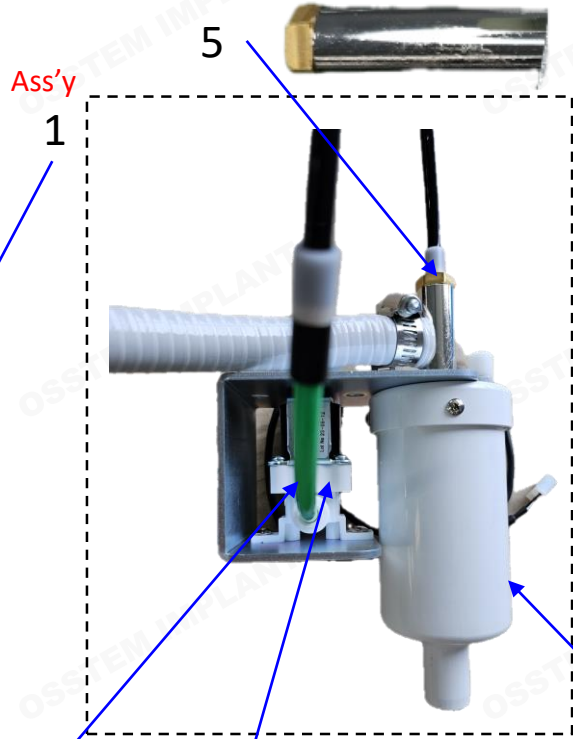
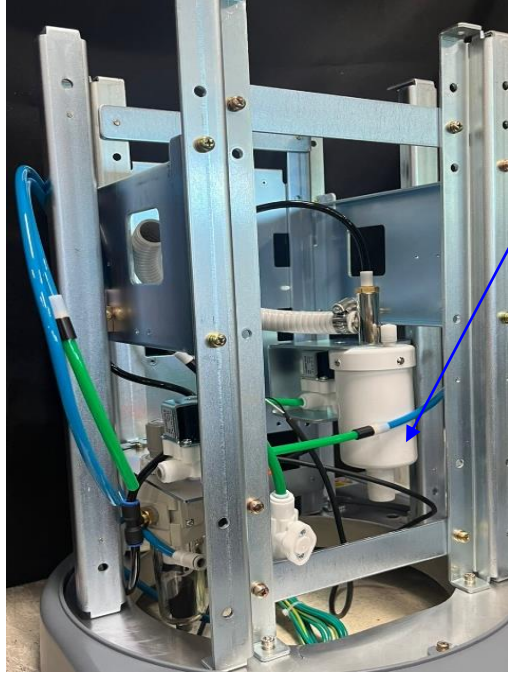

Ass'y

Index	Part code	Part name	Remark
-------	-----------	-----------	--------

1	K3AS	AIR SUCTION ASS'Y	
2	YK3ARLC01	EJECTOR LOWER COVER	
3	YK22WSV04	SOL VALVE (SMC VX212DYXB)	
3-1	YPC0602	SA-PC-06-02(상아)	
3-2	YK22WSV03	HSV-FF-TER180-24V	
4	YK3WSVN12	WATER SOL. V/V NIPPLE (INCH) ASS'Y	
5	YK3ASNA01	AIR SUCTION NIPPLE ASS'Y	

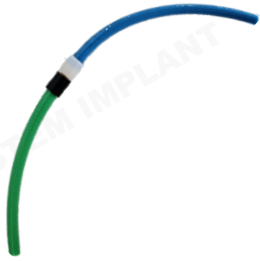

OSSTEM[®] Confidential

OSSTEM[®] Confidential

B. Unit – B12

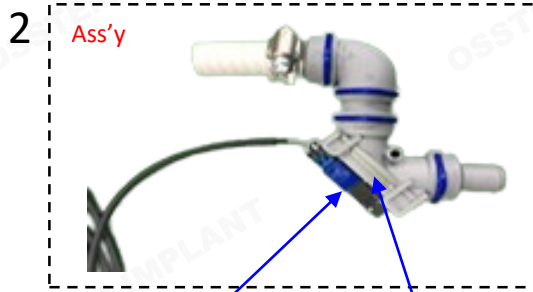

Index	Part code	Part name	Remark
1	K3SPV	Spittoon Bowl Valve Ass'y	
2	K3SUV	Suction Valve Ass'y	
3	YK3DPSV01	DÜRRCONNECT20 PLACE SELECTOR VALVE	
4	YK3DSPM01	MEMBRANE, SUCTION SELECTOR V/V	
5	K3CS1	Water Separator Ass'y	
6-1	YK3DJOT01	DÜRRCONNECT20 T-JOINT (3 PIECES) 2	
6-2	YK3DDCT01	DÜRRCONNECT20 DOUBLE CONNECTOR	
6-3	YK3DSKS01	DRUUCONNECT20 SOCKET Ø = 17MM	
6-4	YK3DEBL01	DÜRRCONNECT20 ELBOWS 90°	
6-5	YK3DEXP01	DÜRRCONNECT20 EXTENSION PIECE	
6-6	YK3DEBS01	DÜRRCONNECT20 ELBOWS 45°	

B. Unit – B13

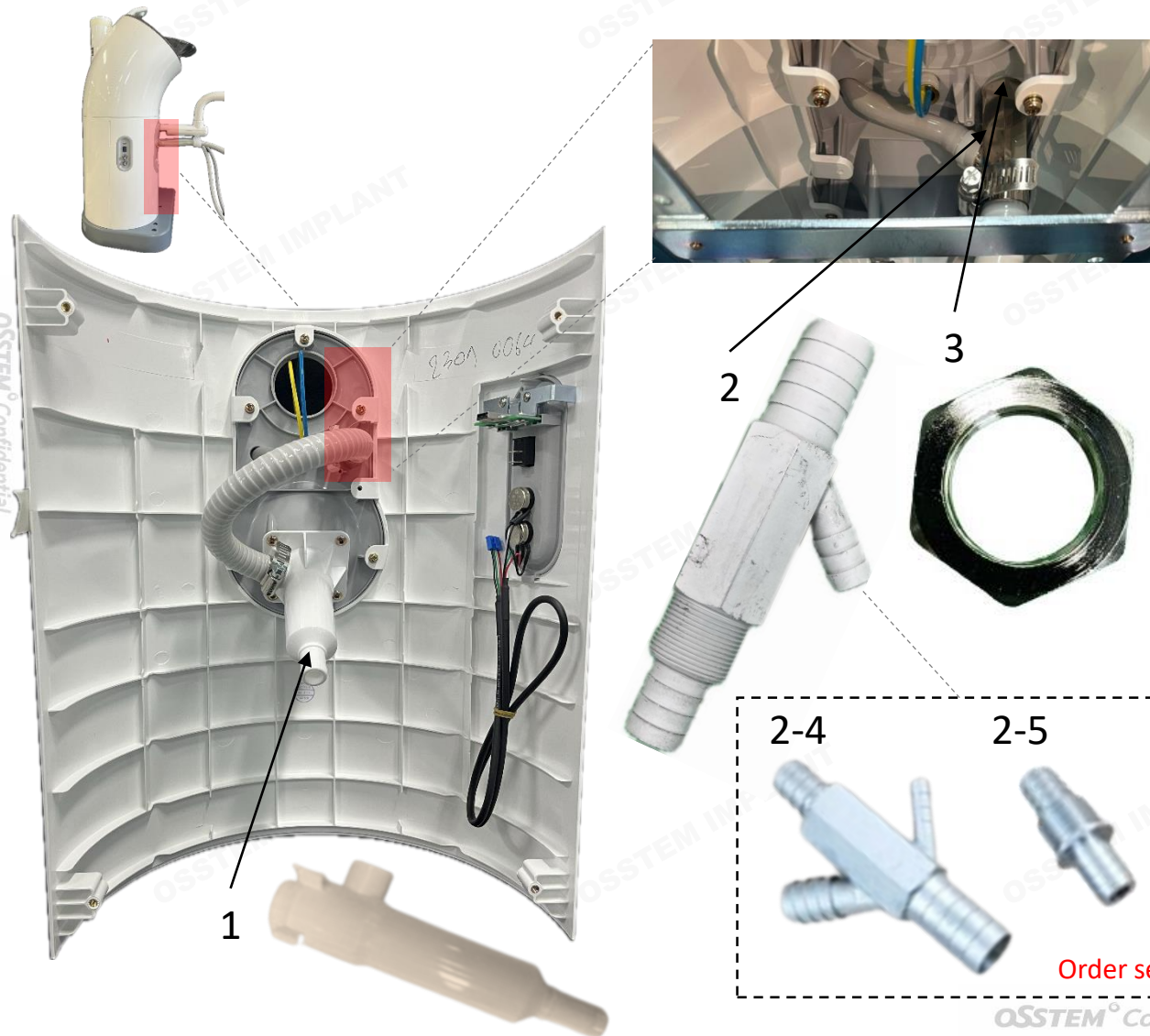

Index	Part code	Part name	Remark
1	YK3STFR01	SUCTION FILTER	
2-1	YK3STBL02	SUCTION BLOCK (METAL)	
2-2	YK3STBL05	SUCTION BLOCK (NIPPLE SIZE UP)(11.5 Ø)	
2-3	YK3-UN0707	SUCTION BLOCK (일본향)	Japan only
2-4	YK3STBL14	SUCTION BLOCK (3WAY) 11.5mm	3way
2-5	YK3STNL03	SUCTION NIPPLE (LARGE) 11.5mm	3way
3	YK3PGET01	PIPE GUIDE NUT	

B. Unit – B14

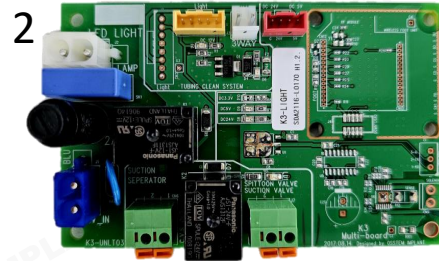
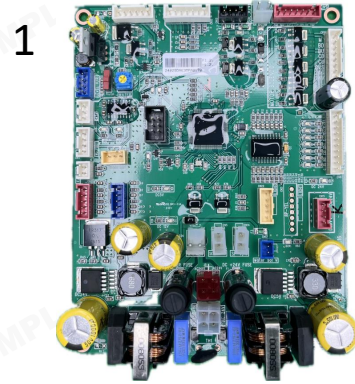
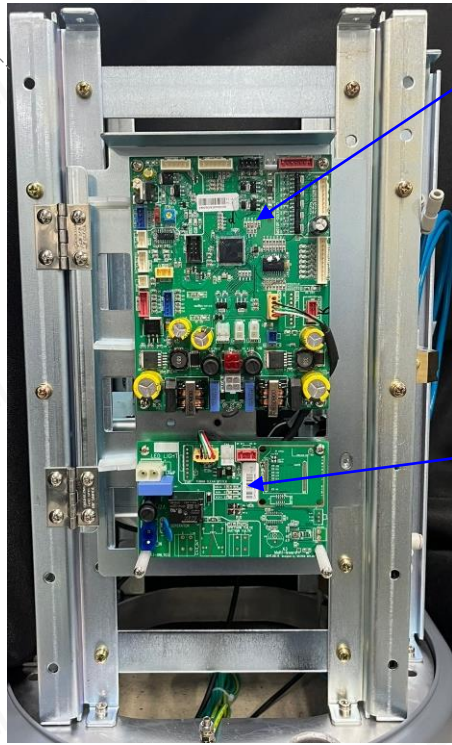

Index	Part code	Part name	Remark
1	YK3MNPB02	MAIN PCB	
2-1	YK3LTPB02	LIGHT PCB	
2-2	YK3LTPB11	LIGHT PCB 1.2V (FULL)	Use only Water separator or spittoon v/v

1

2



B. Unit – B15

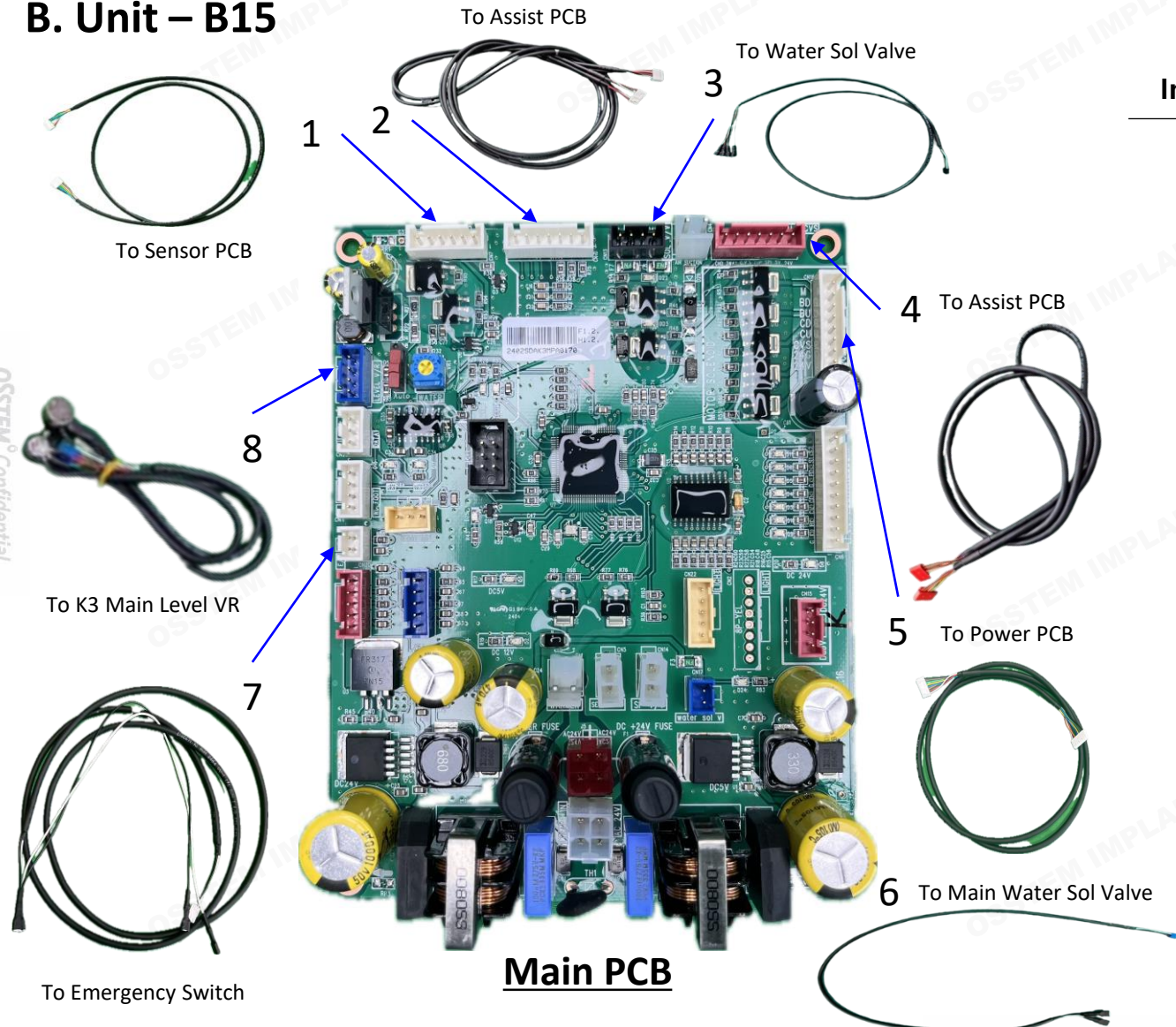

Index	Part code	Part name	Remark
1	YK3NBSR01	K3 MAIN SENSOR	
2	YK3MNAK01	K3 MAIN ASSIST KEY	
3	YK3EXWS02	EXTENTION WATER SOL 4P (NEW)	
4	YK3MNAM02	K3 MAIN ASSIST MANUAL (NEW)	
5	YK3PWDT01	K3 POWER DATA	
6	YK3MWSS01	MAIN WATER SUPPLY SOLENOID VLAVE	
7	YK3MNEY01	K3 MAIN EMERGENCY	
8	YK3MNLV01	K3 MAIN LEVEL VR	



B. Unit – B16

Main PCB

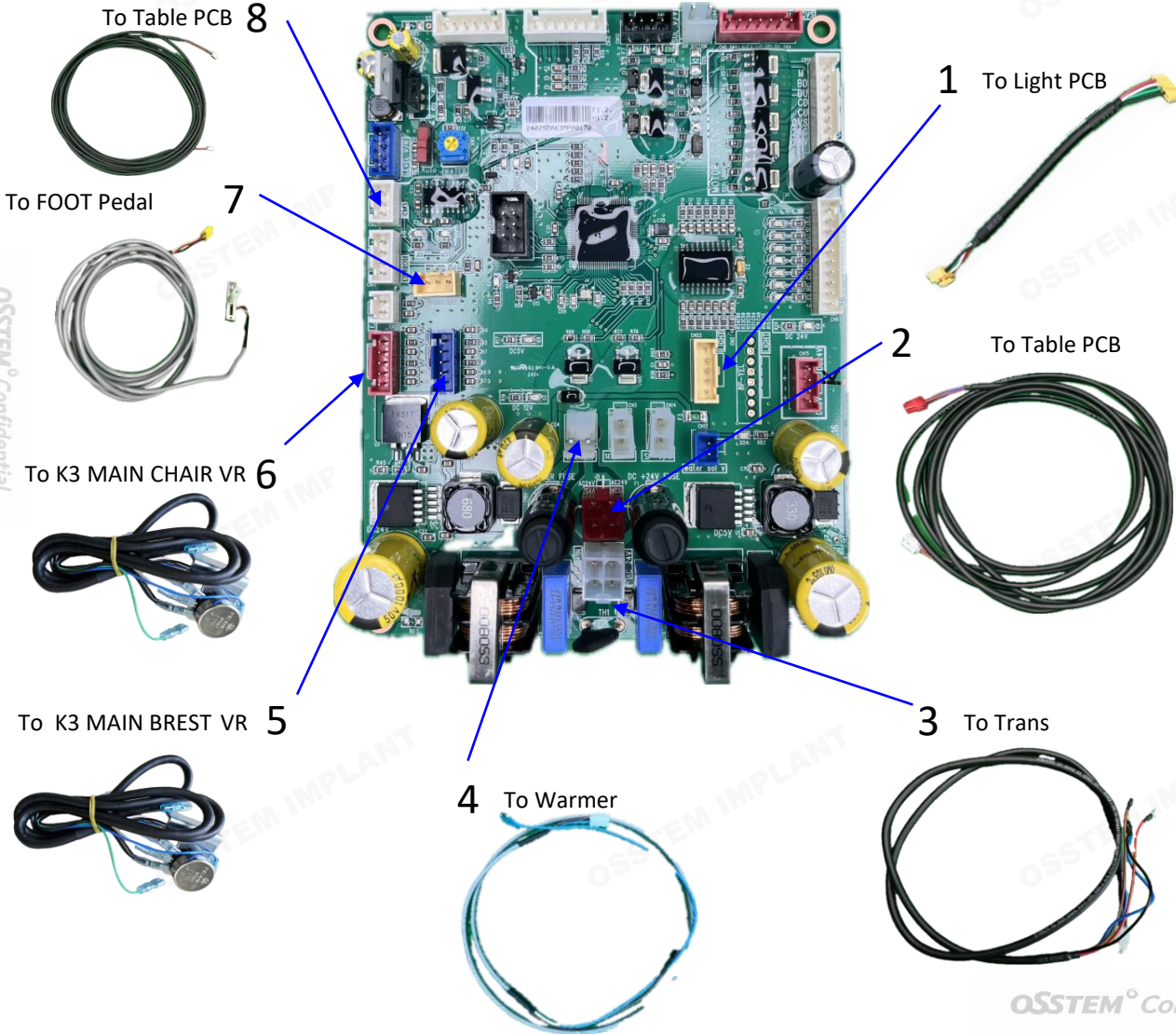

Index	Part code	Part name	Remark
1	YK3LTDA01	K3 LIGHT DATA	
2-1	YK3TEPM01	TABLE POWER (Harness)	Mount Type
2-2	YK3TEPC01	TABLE POWER (Harness)	Cart Type
3	YK3MNP01	K3 MAIN POWER	
4	YK3WPSH01	K3 WARMER POWER SWITCH	
5	YK3MNBV01	K3 MAIN BREST VR	
6	YK3MNCV01	K3 MAIN Chair VR	
7	YK3PCPP01	SU2011-103 (풋 가변저항) ASS'Y	Adjustable resistance
8-1	YK3TDAM01	K3 TABLE DATA (Harness)	Mount Type
8-2	YK3TDAC01	K3 TABLE DATA (Harness)	Cart Type



B. Unit – B17

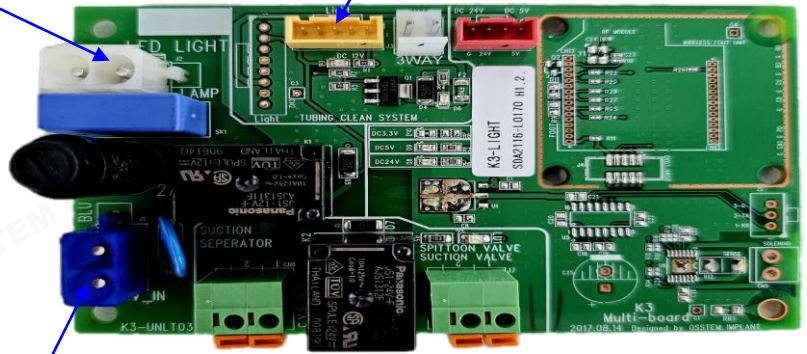

Light PCB



Index	Part code	Part name	Remark
1	YK3LIMH01	K3 LED LIGHT MAIN HARNESS	
2	YK3LTDA01	K3 LIGHT DATA	
3	YK3LTVCO1	K3 LIGHT 12VAC	

OSSTEM Confidential

OSSTEM Confidential

B. Unit – B18

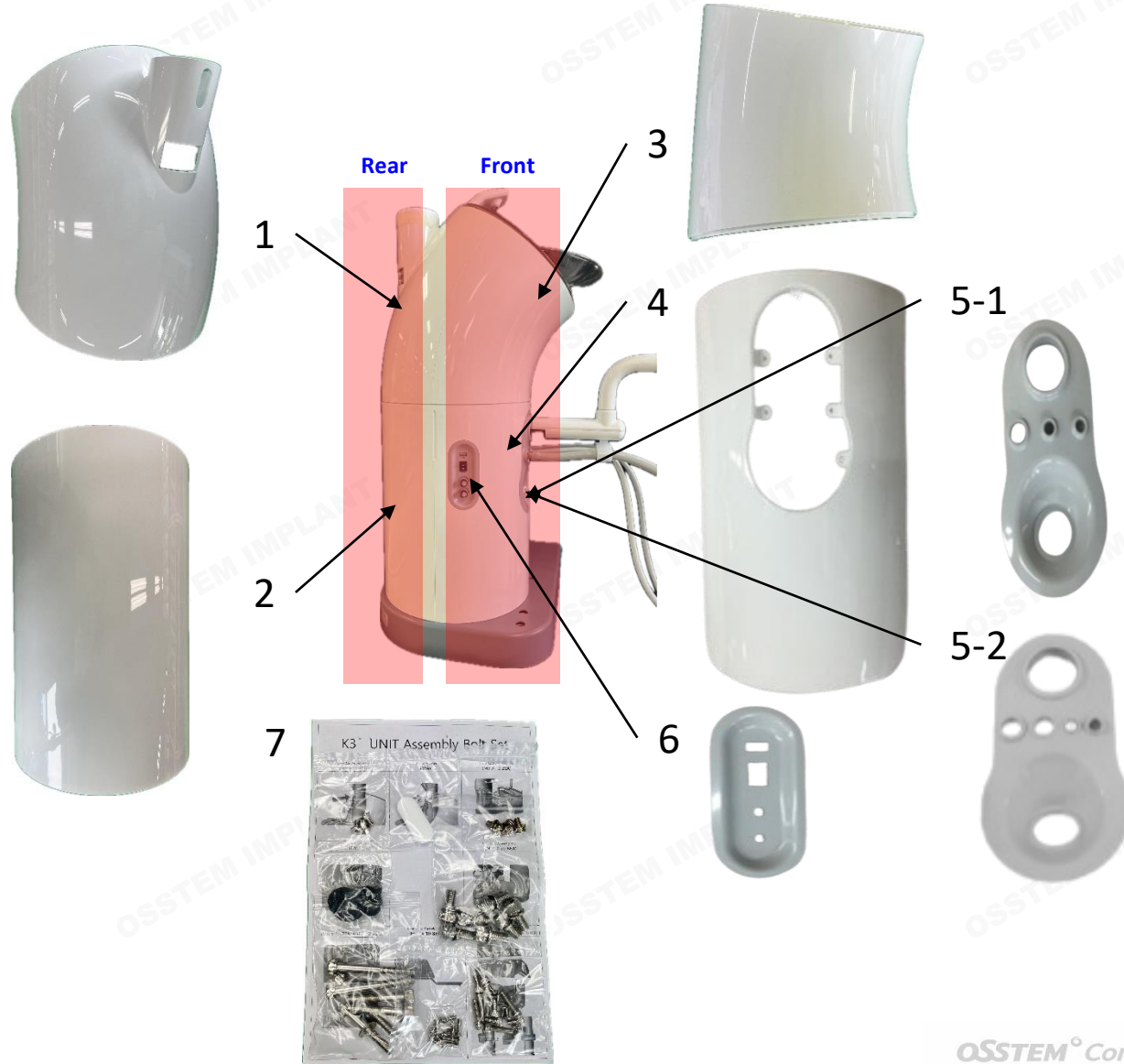

Index	Part code	Part name	Remark
1	YK3BUSC01	BACK UPPER SIDE COVER	
2	YK3BLCR01	BACK LOWER COVER	
3	YK3FUSC01	FRONT UPPER SIDE COVER	
4	YK3FLCR02	FRONT LOWER COVER	
5-1	YK3SNOR02	SUCTION COVER	3 hole
5-2	YK3SNOR11	SUCTION COVER (확장형)	4 hole
6	YK3KBCR01	KNOB COVER	
7	YK3UNA008	K3 UNIT BOLT KIT (해외)	

(C) Assist Table

C. Assist Table



C. Assist Table – C1

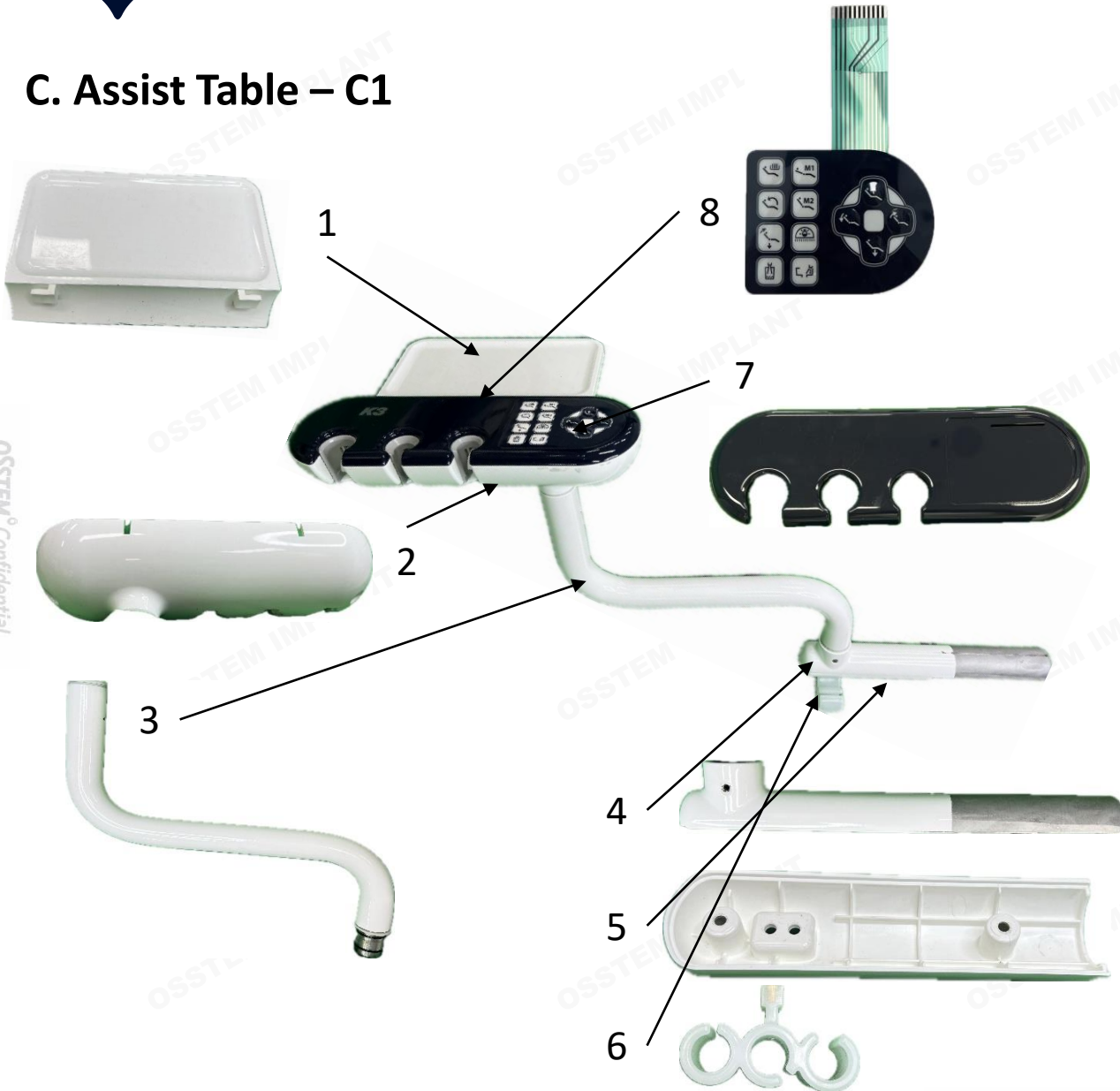

Index	Part code	Part name	Remark
1	YK3ATTE01	ASSIST TABLE	
2-1	YK3ATBC01	ASSIST TABLE BOTTOM COVER	
2-2	YK3ASBC01	ASSIST TABLE BOTTOM COVER (확장형)	4 hole
3	YK3ATPE01	ASSIST PIPE ASS'Y	
4	YK3APTR01	ASSIST PIPE TOP COVER	
5	YK3APBC01	ASSIST PIPE BOTTOM COVER	
6	YK3TUBH01	ASSIST TUBING HOLDER	
7-1	YK3ATTC02	ASSIST TABLE TOP COVER (NEW)	BR, DV, DB, BL, GR
7-2	YK3ASTC01	ASSIST TABLE TOP COVER (확장형)	BR, DV, DB, BL, GR
8-1	YK3ATME01DB	K3 ASSIST TABLE MEMBRANE (DARK BLUE)	
8-2	YK3ATME01BR	K3 ASSIST TABLE MEMBRANE (BROWN)	
8-3	YK3ATME01GY	K3 ASSIST TABLE MEMBRANE (GRAY)	

C. Assist Table – C2

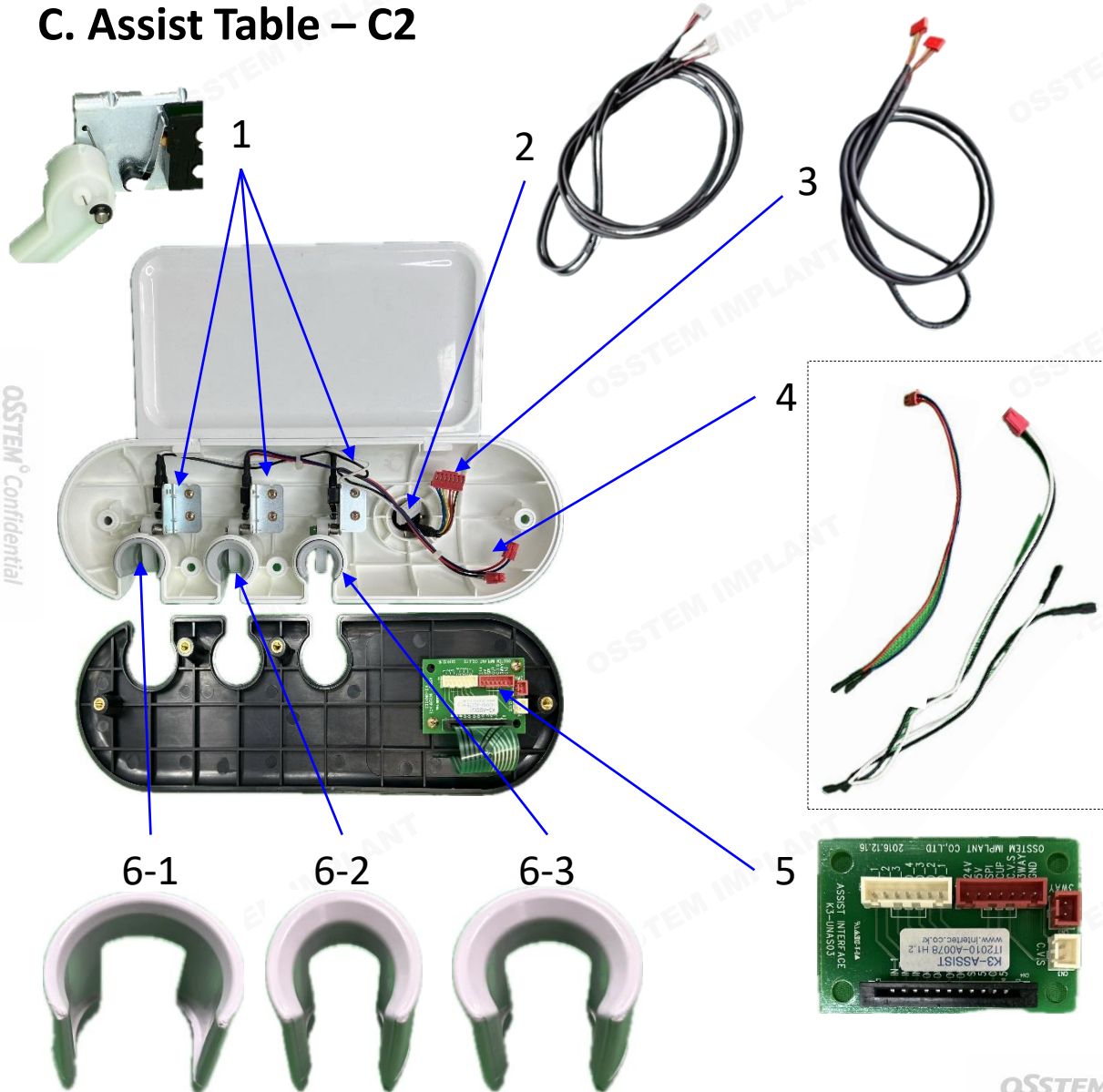

Index	Part code	Part name	Remark
1	YK3MSBA01	MICRO SWITCH ASS'Y	
2	YK3MNAK01	K3 MAIN ASSIST KEY	harness
3	YK3MNAM02	K3 MAIN ASSIST MANUAL (NEW)	
4-1	YK3AMSH01	K3 ASSIST MICRO SWITCH	
4-2	YK3AMSH12	ASSIST TABLE MICRO SWITCH NEW (확장형)	extended
5	YK3ASBB02	ASSIST SUB. PCB	
6-1	YK3ATHL11	SUCTION HOLDER(대) ASA	Suction large
6-2	YKETHHH11	HIGH HANDPIECE HOLDER ASA	Syringe
6-3	YK3ATHS11	SUCTION HOLDER(소) ASA	Suction small

(D) Dr. Table



D. Dr. Table – D1

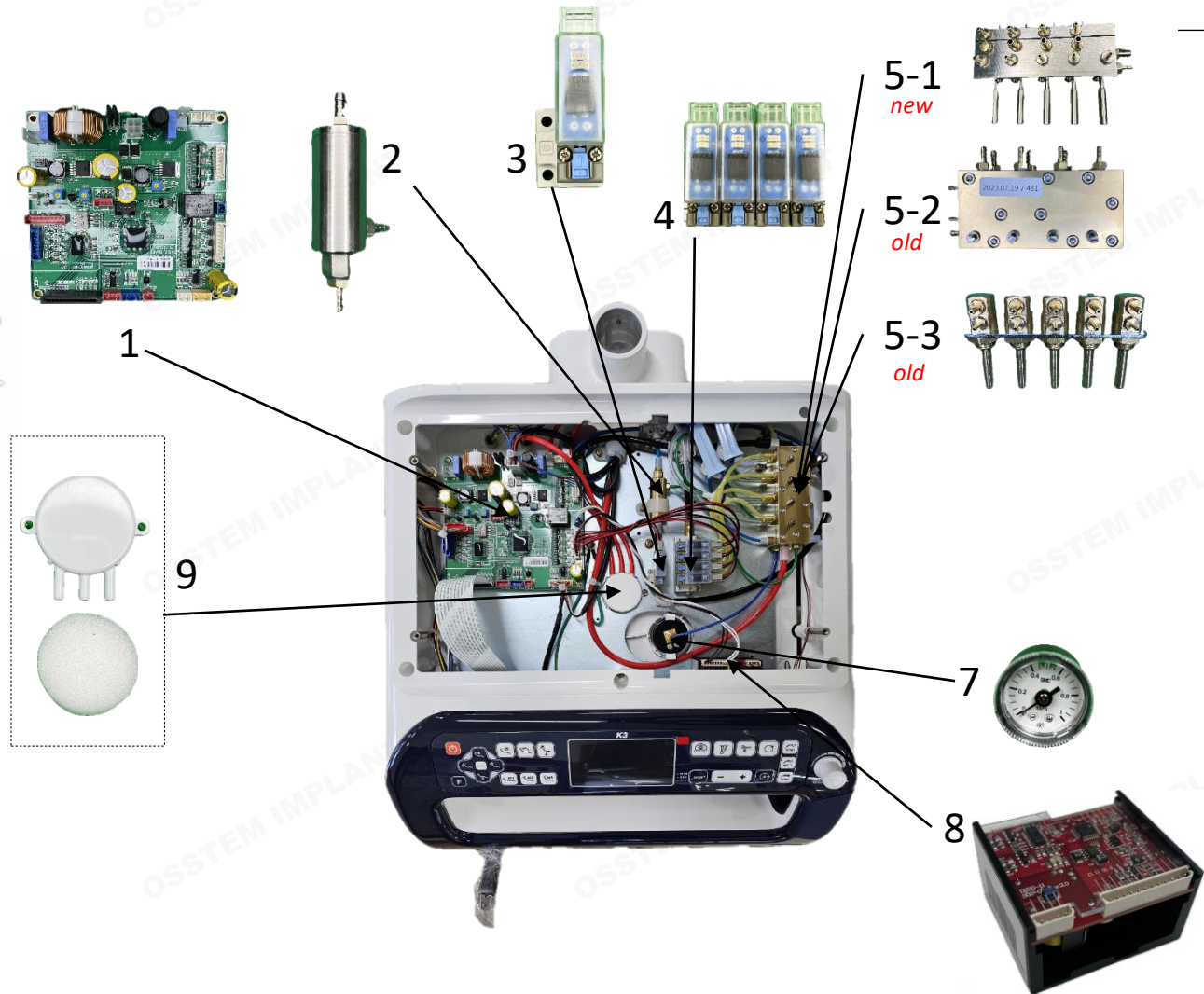

Index	Part code	Part name	Remark
1	YK3TBPC02	TABLE PCB	
2	YK2WTVL01	WATER VALVE ASS'Y	
3	YK2MRVL02	V114A-5MU-M5 (1CH SOL VALVE)	1CH sol valve
4	YK2MCCV02	V124A-5MU (4)	4CH sol valves
4-1	YK2MCCV12	V124A-5MOU	
5-1	YK3MAAY02	K3 MASTER BLOCK ASS'Y (NEW)	New
5-2	YK3MAAY01	MASTER BLOCK ASS'Y	old
5-3	YK3WCAY02	WATER CUTTER VALVE ASS'Y (NEW)	old
6-1	YK2MVPD94	Master Block PAD (New)	New
6-2	YK2MVPD93	Master Block PAD	old
7	YK2PSGG01	PRESURE GAUGE	
8-1	S3_GENERATOR	S3 BIK US GENERATOR C51(EJ-021)	EMS S5
8-2	S5_MODULE_D	S5 BIK US MODULE TYPE F (EJ-110A/D_REV_D)	EMS S3
8-3	SONIC BUFF 3003	DIT SCALER PCB	DIT
8-4	COMPACT S3	COMPACT PCB	Demetec
9	YK3DFCP01	Drain Filter Cap	

D. Dr. Table – D2



Index	Part code	Part name	Remark
1	YK3MUCR01	MAIN UPPER COVER	
2-1	YK3FUCR02DB	FRONT UPPER COVER (DARK BLUE)	Dark Blue
2-2	YK3FUCR02GY	FRONT UPPER COVER (GRAY)	Gray
2-3	YK3FUCR02BR	FRONT UPPER COVER (BROWN)	Brown
2-4	YK3FUCR02DV	FRONT UPPER COVER (DARK VIOLET)	Dark Violet
2-5	YK3FUCR02BL	FRONT UPPER COVER (BLUE)	Blue Light
3	YK3SRKB01	SCALER KNOB	
4-1	S5_POTENTIOMETER	S5 BIK POTENTIOMETER AND CAP SET(EL-457)	EMS S5
4-2	S3_POTENTIOMETER	S3 BIK POTENTIOMETER AND CAP SET(EL-457)	EMS S3
4-3	SONIC BUFF 3004	DIT 가변저항	DIT POTENTIOMETER
4-4	COMPACT S4	HARNESS CABLE	Demetec
5	YK3CTLB01	Cart Table Lower Block	

D. Dr. Table – D3

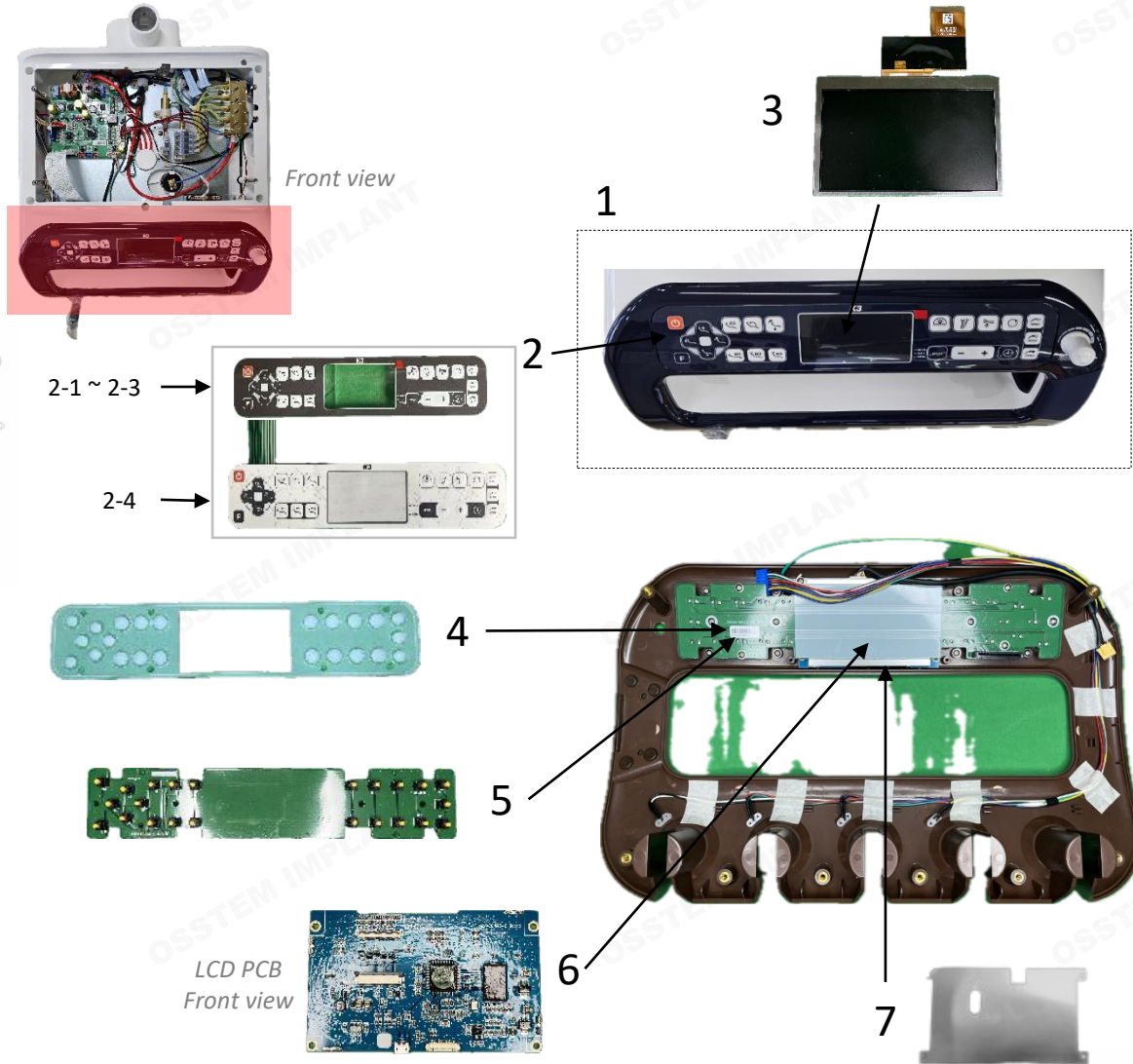

Index	Part code	Part name	Remark
1-1	K3TKDB	K3 TACT KEY FRONT COVER ASS'Y (D/BBLUE)	
1-2	K3TKBR	K3 TACT KEY FRONT COVER ASS'Y (BROWN)	
1-3	K3TKBL	K3 TACT KEY FRONT COVER ASS'Y (BLUE)	Except for Table LCD, LCD PCB
1-4	K3TKDV	K3 TACT KEY FRONT COVER ASS'Y (D/VIOLET)	
1-5	K3TKGY	K3 TACT KEY FRONT COVER ASS'Y (GRAY)	
2-1	YK3TCSP01DB	TACT KEY PAD (DARK BLUE)	
2-2	YK3TCSP01GY	TACT KEY PAD (GRAY)	
2-3	YK3TCSP01BR	TACT KEY PAD (BROWN)	
2-4	YK3NNBE02	K3 MEMBRANE (NEW)	China only
3	YK3TFTL02	4.3" TFT-LCD	Table LCD
4	YK3TCBS01	TACT BUTTON SEAL	
5	YK3TSPB01	TACT_SW_EXTRA PCB	Tack Key PCB
6	YK3LDPB02	GL-CON32-0 (LCD PCB)	LCD PCB
7	YK3SHDC11	LCD SHIELD CAN (A/S)	

D. Dr. Table – D4



Index	Part code	Part name	Remark
1	YK2KNOB01	TABLE KNOB (F-2)	
2	YK3CTPP01	CART BASE PIPE (ABS 타원형 PIPE 68*133)	
3	YK3CTBE02	CART MAIN POST (NEW)	
4-1	YK3DFBE01	DRAIN FILTER BOTTLE	
4-2	YK3DFSP01	DRAIN FILTER SPONGE	
5-1	YK2CAST02	CASTER (일반)	General type
5-2	YK2CAST11	CASTER (스토퍼)	Stopper type

D. Dr. Table – D5



Index	Part code	Part name	Remark
1-1	OSP-SLT001	3-WAY SYRINGE TUBING(30M)	1 roll (30m)
1-2	YK3SGTB01	3-WAY SYRINGE TUBING (1.5M)	1.5m
2	YT-1706.H2437C	6 HOLE OPTIC TUBING (CN)	
3-1	YT-1704.H2436C	4 HOLE MIDWEST TUBING WITHOUT LIGHT (CN)	air
3-2	EIL_HOSE	HOSE MCX GREY 1600756-001	Electric (Bien-air)
4-1	S5_CORD	S5 BIK HANDPIECE CORD 2.00M (EM-153A/A)	EMS S5
4-2	S3_CORD	S3 BIK HANDPIECE CORD 1.80M(EM-064)	EMS S3
4-3	SONIC BUFF 3002	DIT SCALER TB	DIT
4-4	COMPACT S2	COMPACT TB	Demetec
5	YK3CATH01	K3 CART STEEL HOSE	

D. Dr. Table – D6



Index	Part code	Part name	Remark
1	YK3CTBK01	CHART BRK	
2	YK3TYCR01	TRY COVER	rubber
3	YK3MSPT01	MOUSE PAD TRY	
4	YK3MEPD01	MOUSE PAD (사출)	
5	YK3SDTB02	SIDE TABLE (NEW)	
6	YK3SQTR01	METAL TRAY	
7	K3TYCR01	TRY COVER	
8-1	YK3THHH11	HIGH HANDPIECE HOLDER ASA	
8-2	YK3TLHH11	LOWER HANDPIECE HOLDER ASA	
8-3	YK3TSC11	SCALER HOLDER ASA	



D. Dr. Table – D7

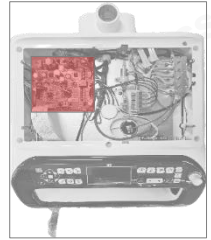
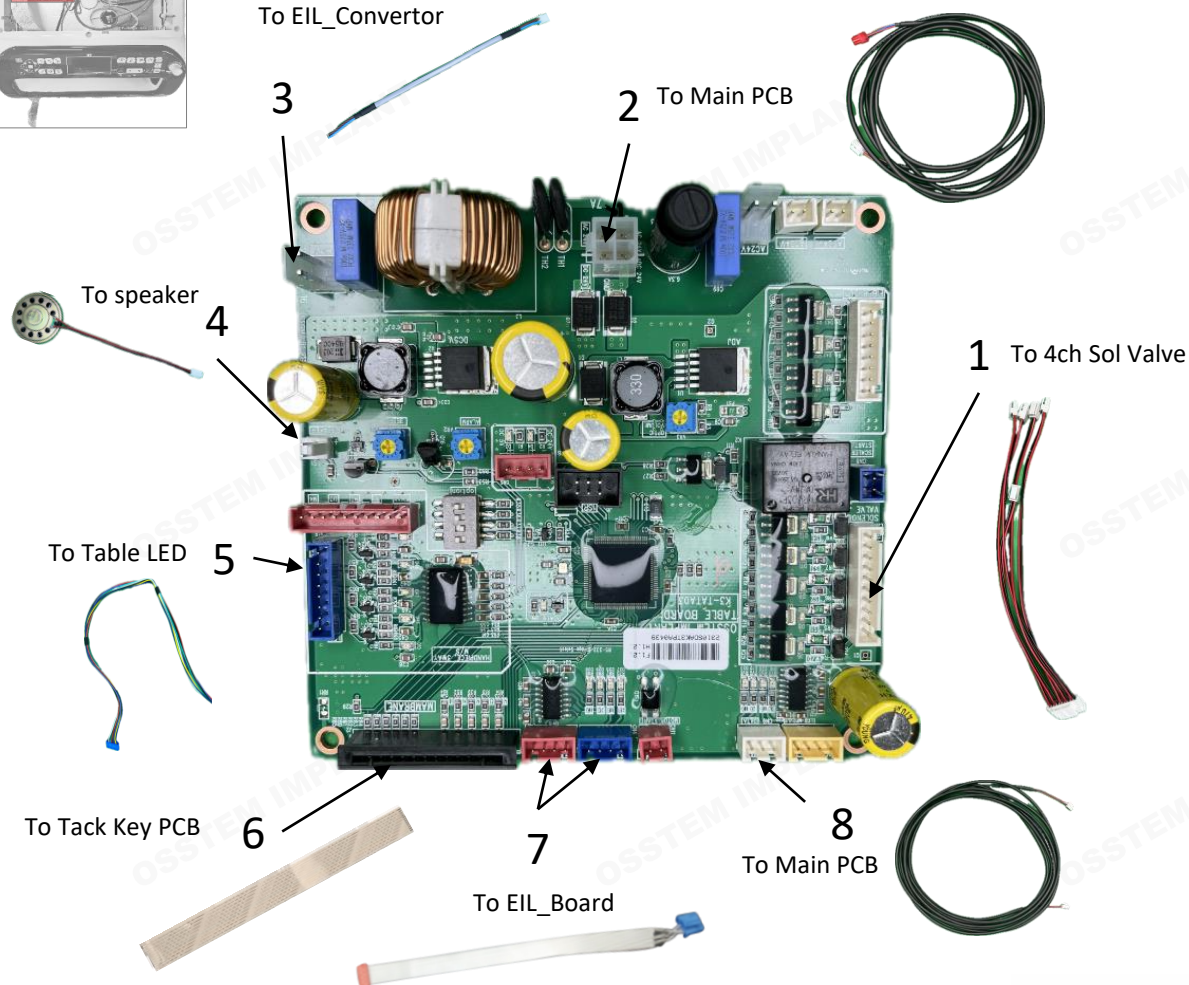

Table PCB



Index	Part code	Part name	Remark
1	YK3TMSL01	K3 TABLE MINI SOL (Harness)	
2-1	YK3TEPM01	TABLE POWER (Harness)	Mount Type
2-2	YK3TEPC01	TABLE POWER (Harness)	Cart Type
3	YK3TDVA01	K3 TKD 24VAC (AC POWER) (Harness)	
4	YK2SPKR01	SPEAKER(57MM) ASS'Y (Harness)	
5	YK3TELD01	K3 TABLE LED (Harness)	
6	YK3FFCC01	FFC CABLE (2.54*12P*300MM*C) (Harness)	
7	EIL_CABLE	CABLE RS232 (Harness)	
8-1	YK3TDAM01	K3 TABLE DATA (Harness)	Mount Type
8-2	YK3TDAC01	K3 TABLE DATA (Harness)	Cart Type

(E) Light

E. Light





E. Light – E1



Index	Part code	Part name	Remark
1	YK3LI0402	K3 LED LIGHT HANDLE COVER	
2	YK3LI0500	K3 LED LIGHT HANDLE ASS'Y R	
3	YK3LI0327	K3 LED LIGHT SWITCH POLE COVER	
4	YK3LTGS01	K3 LED LIGHT TOGGLE SWITCH ASS'Y	
5	YK3LI0310	K3 LED LIGHT DIMMING BUTTOM	
6	YK3LI0309	K3 LED LIGHT LAMP BODY BUTTOM	
7	YK3LI0301	LAMP BODY TOP	
8	YK3LI0400	K3 LED LIGHT HANDLE ASS'Y L	
9-1	YK3LI0311A1	K3 LED LIGHT SCREW CAP 1	Index a
9-2	YK3LI0311A2	K3 LED LIGHT SCREW CAP 2	Index b
9-3	YK3LI0311A3	K3 LED LIGHT SCREW CAP 3	Index c
9-4	YK3LI0311A4	K3 LED LIGHT SCREW CAP 4	Index d
9-5	YK3LI0311A5	K3 LED LIGHT SCREW CAP 5~6	Index e,f



E. Light – E2

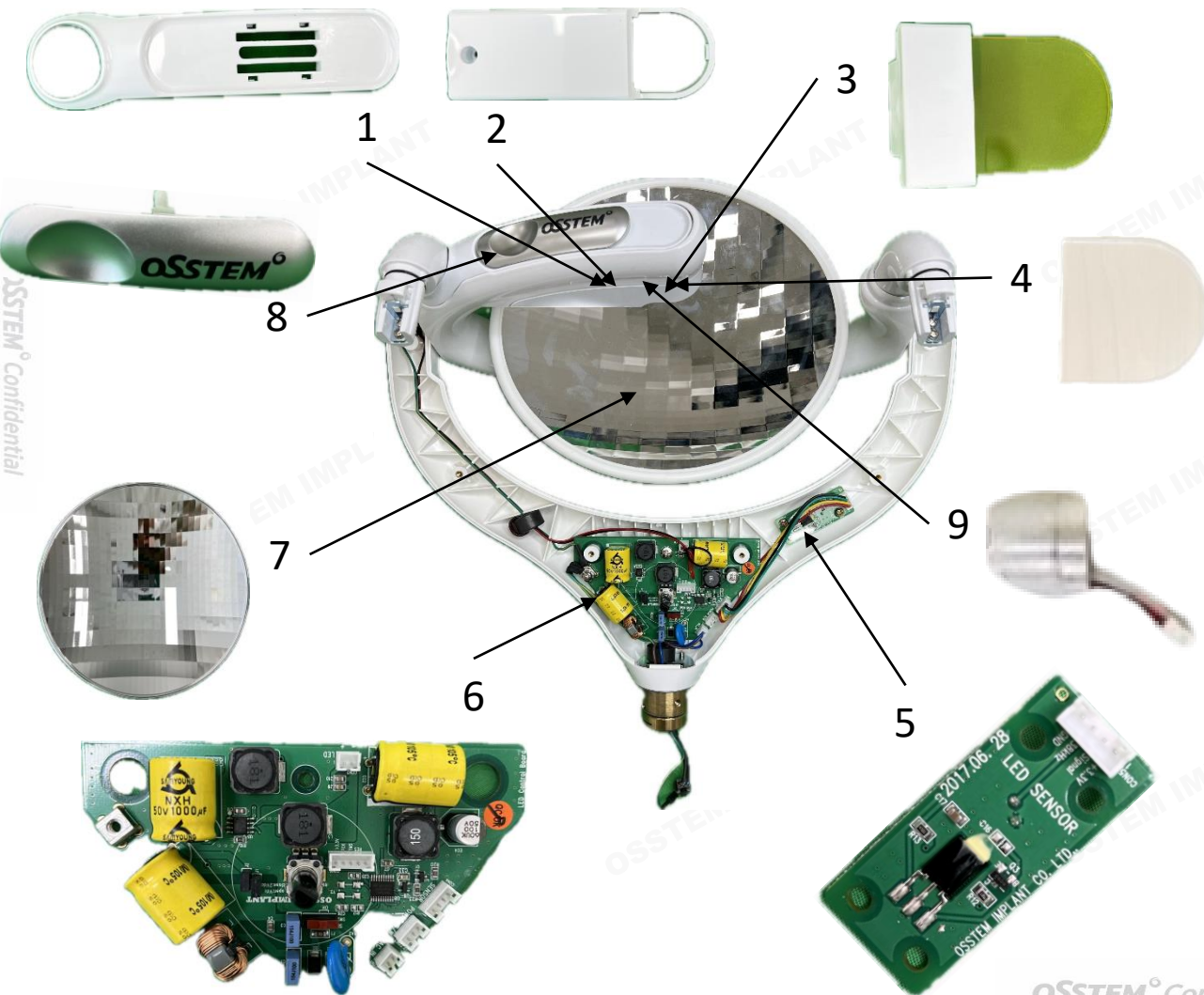

Index	Part code	Part name	Remark
1	YK3LI0326	FRONT BAR TOP COVER	
2	YK3LI0321	K3 LIGHT FRONT BAR BOTTOM COVER	
3	YK3LI0328	K3 LED LIGHT BLUE CUT FILTER ASS'Y	
4	YK3LI0322	K3 LED LIGHT BLUE CUT LENS	
5	YK3LSPC01	K3 LED LIGHT SENSOR PCB	
6-1	YK3LMPC01	K3 LED LIGHT MAIN PCB	Only PCB
6-2	YK3EMPC01	K3 LED LIGHT MAIN PCB ASS'Y (A/S)	PCB With Toggle Switch
7	YK3LI0320	K3 LED LIGHT REFLECTOR	
8	YK3LI0325	K3 LED LIGHT BUTTOM	
9	YK3LAMP01	K3 LED LIGHT LED LAMP	

E. Light – E3



Index	Part code	Part name	Remark
1	YK3LI0329	K3 LED LIGHT REFLECTOR COVER	
2	YK3LI0308	K3 LIGHT SENSOR COVER	
3	YK3LI0314	K3 LED HINGE CAP	
4	YK3LI0313	K3 LED LIGHT HOUSING	

(F) Light Arm



F. Light Arm – F1



Index	Part code	Part name	Remark
1	YELED02	K3 LED LIGHT ASS'Y (OSL-1)	Whole pats
2	YBLED02	K3 LED LIGHT BALANCE ARM ASS'Y	3 & 4 & 5 & 6
3	YBBLA02	K3 LED LIGHT LINK ARM ASS'Y	
4	YBSWA02	K3 LED LIGHT SWING ARM	With No.5
5	YK3LIMH01	K3 LED LIGHT MAIN HARNESS	
6	YK3LTPK01	LIGHT ARM PAKING	
7	YHLED02	K3 LED LIGHT HEAD ASS'Y W PACKING	
8-1	YK3LTPL01	K3-LIGHT POLE (Mount) 540mm	
8-2	YK3CTLP01	K3-LIGHT POLE (CART) 703mm	
9	YK3MOPK01	MONITOR ARM PAKING	

(G) Hanaro Console



G. Hanaro Console – G1

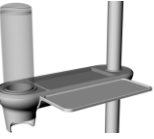

Index	Part code	Part name	Remark
1	K3MT	3MULTI Table Ass'y	Whole parts
2	YK3MTBD01	Main top body	
3	YK3HODE01	Holder	
4	YK3CEPC01	CUP dispense cap	
5	YK3CDBY01	Cup dispense body	
6	YK3MABD01	Main body	
7	YK3MABR01	Main body R	
8	YK3MTBR01	Main top body R	

G. Hanaro Console – G2

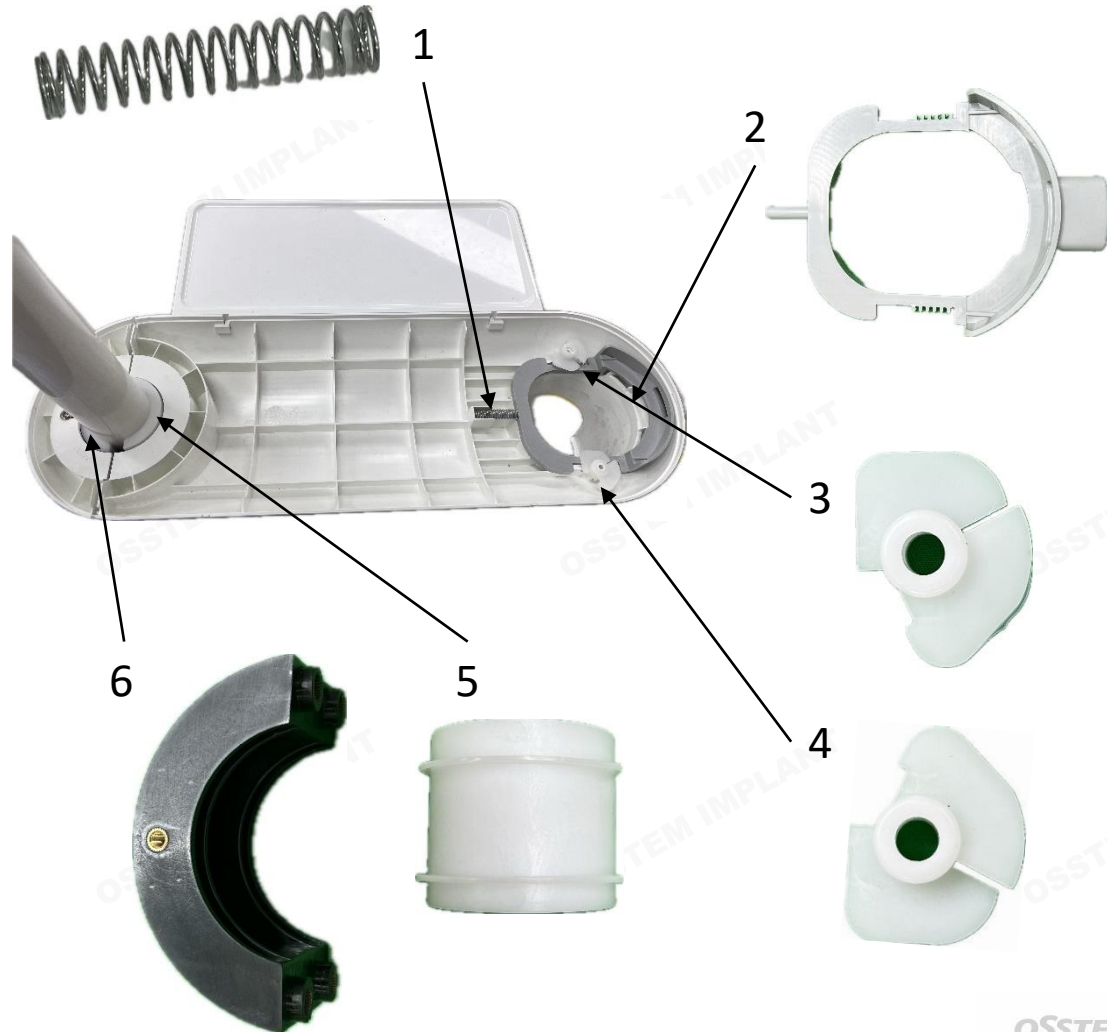
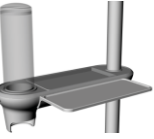

Index	Part code	Part name	Remark
1	YK3CESG01	CUP EJECTOR SPRING	
2	YK3CEBT01	Cup ejector button	
3	YK3CEWR01	Cup ejector Wing R	
4	YK3CEWL01	Cup ejector Wing L	
5	YK3SPIS01	Support insert	
6	YK3PLSP01	Pole Support	

(H) Monitor Arm



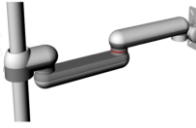

H. Monitor Arm – H1

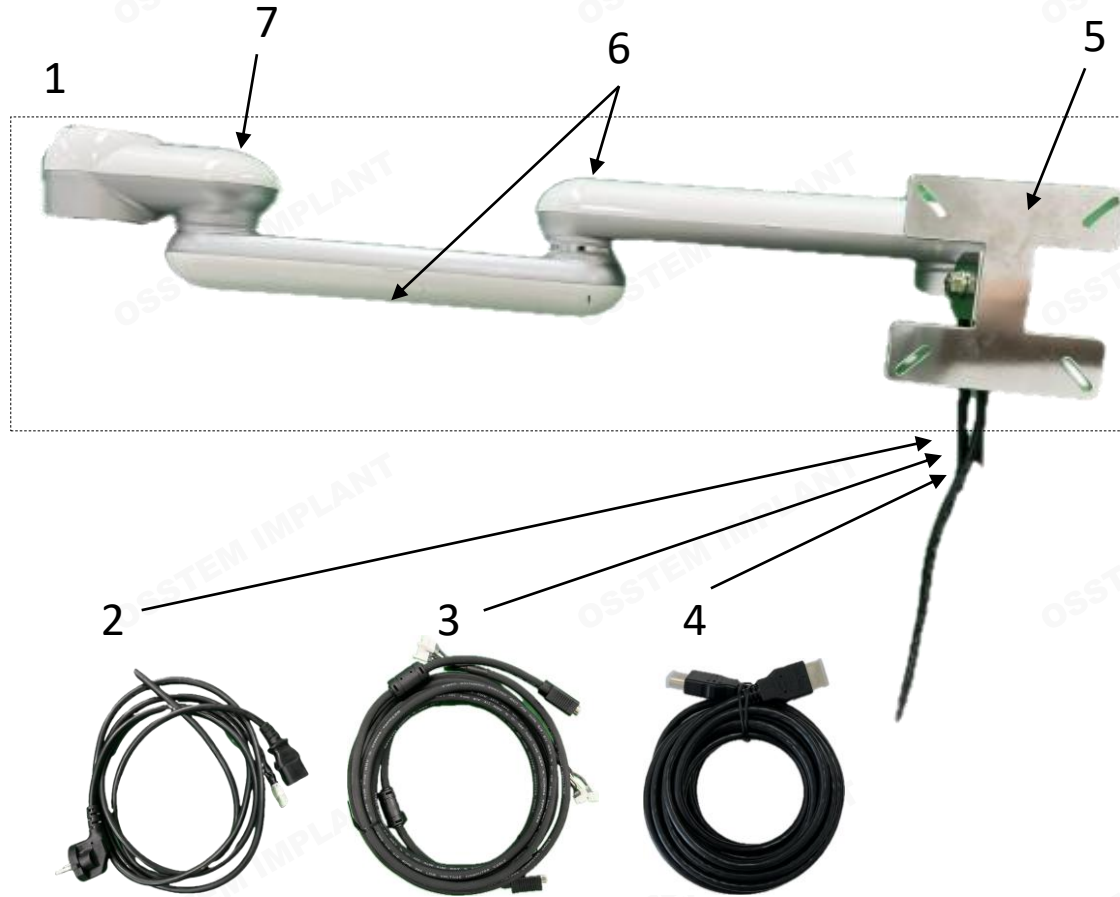

Index	Part code	Part name	Remark
1	K3MAA	MONITOR ARM ASS'Y	
2	YK3MTPW01	K3 MONITOR POWER	
3	YK3MRCE01	RGB CABLE	
4	YHDMC01	HDMI CABLE	
5	YK3MAHA01	MONITOR ARM HEAD ASS'Y	
6	YK3MACV01	MAIN ARM COVER	
7	YK3PABC01	POLE ARM BODY COVER	

(I) Balance Arm



I. Balance Arm – I1

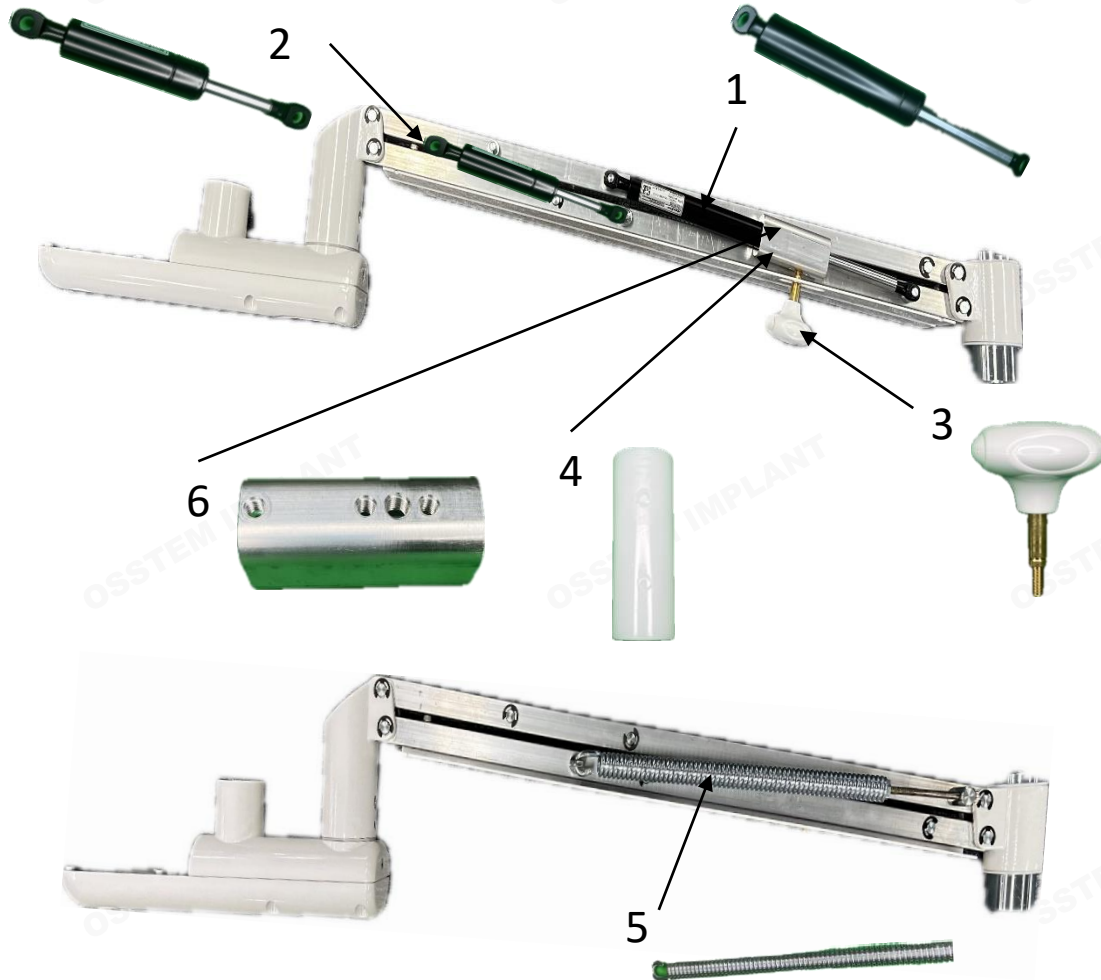

Index	Part code	Part name	Remark
1	YK3GSSG01	GAS SPRING (120kg)	120kg
2	YK3GSSS01	GAS SPRING 70KG	70kg
3	YK3BAKB01	BALANCE ARM KNOB	
4	YK3GSSR01	GAS SPRING STOPPER	2EA
5	YK3BASG01	BALANCE ARM SPRING	
6	YK3GSSB02	GAS SPRING STOPPER BODY	



I. Balance Arm – I2



Index	Part code	Part name	Remark
1	YK3UTBK01	UPPER TABLE BLOCK	
2	YK3LTEB01	LOW TABLE BLOCK	
3	YK3KCEB01	KNUCKLE B (K3)	
4	YK3KCEA01	KNUCKLE A (K3)	
5	YK3SBUC02	SLIDE BAR UPPER COVER	
6	YK3KBWR01	KNUCKLE B WASHER	
7	YK3KAWR01	KNUCKLE A WASHER	
8	YK3SCPL01	SLIDE BAR COVER PLATE L	left
9	YK3SCPR01	SLIDE BAR COVER PLATE R	right

(J) Foot Pedal

J. Foot Pedal





J. Foot Pedal (air) – J1

7



Index	Part code	Part name	Remark
1	YK3BTTL01	BUTTON-L	
2	YK3FPPT01	FOOT PEDAL PLATE ASS'Y (고무판포함)	Including rubber plate
3	YK3BTTR01	BUTTON-R	
4	YK3FLRB01	FOOT LEVER RUBBER ASS'Y	
5	YK3FLBC01	FOOT LEVER BOTTOM COVER	
6	YK3FTHK01	FOOT HOOK	
7-1	K3EFB	FOOT ASS'Y (Electric)	Electric
7-2	K3FB	FOOT ASS'Y	Air

J. Foot Pedal – J2

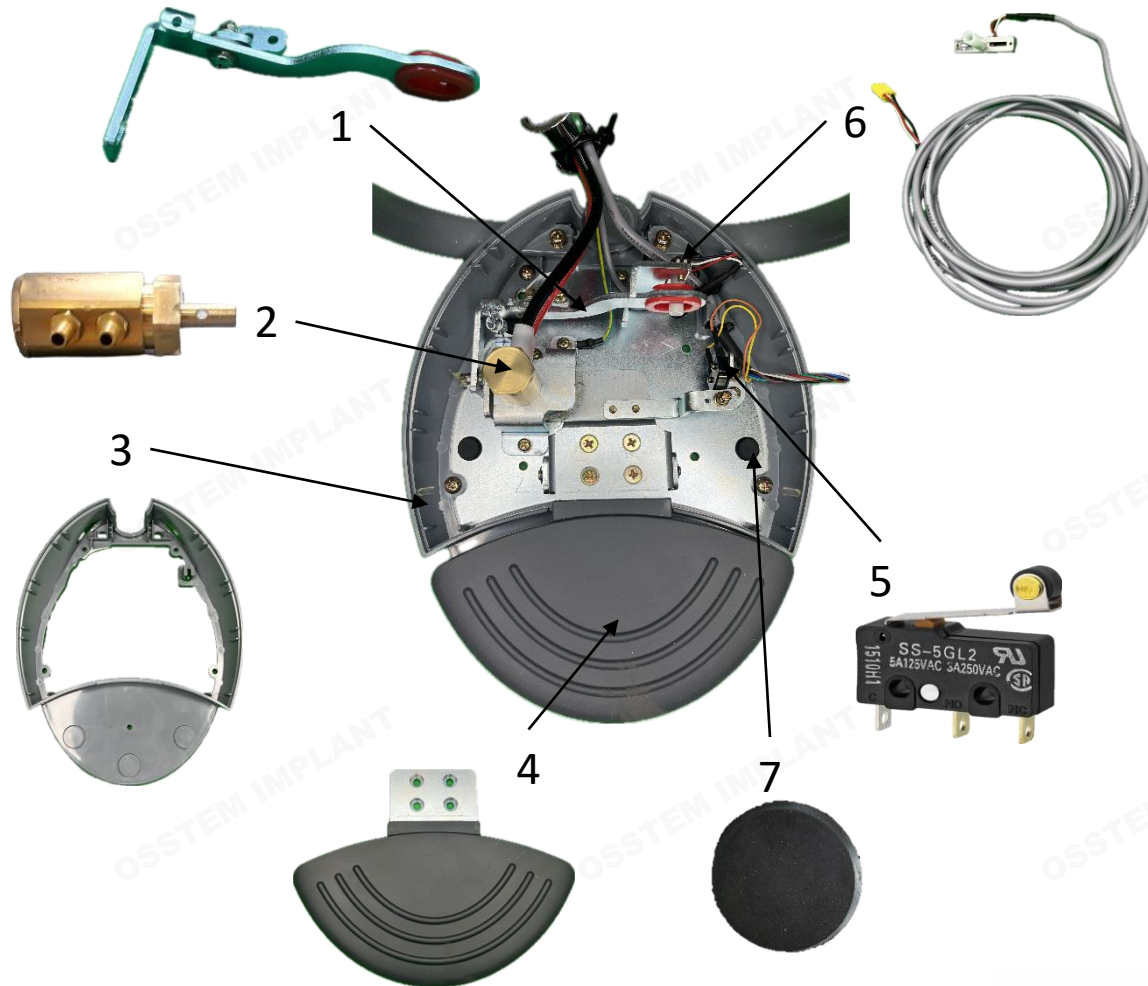

Index	Part code	Part name	Remark
1	YK3-FC0006	HINGE GUIDE PLATE ASS'Y	
2	YK3FACB01	K3 FOOT CONTROL BLOCK V/V	
3	YK3FBCV01	FOOT-BOTTOM-COVER	Air
4	YK3FPPT01	FOOT PEDAL PLATE ASS'Y (고무판포함)	Including rubber plate
5	YK2MSBK01	M/S (BLACK) SS-5GL2	
6	YK3PCPP01	SU2011-103 (풋 가변저항) ASS'Y	Adjustable resistance
7	YK3FBRB01	FOOT BASE RUBBER	



J. Foot Pedal – J3

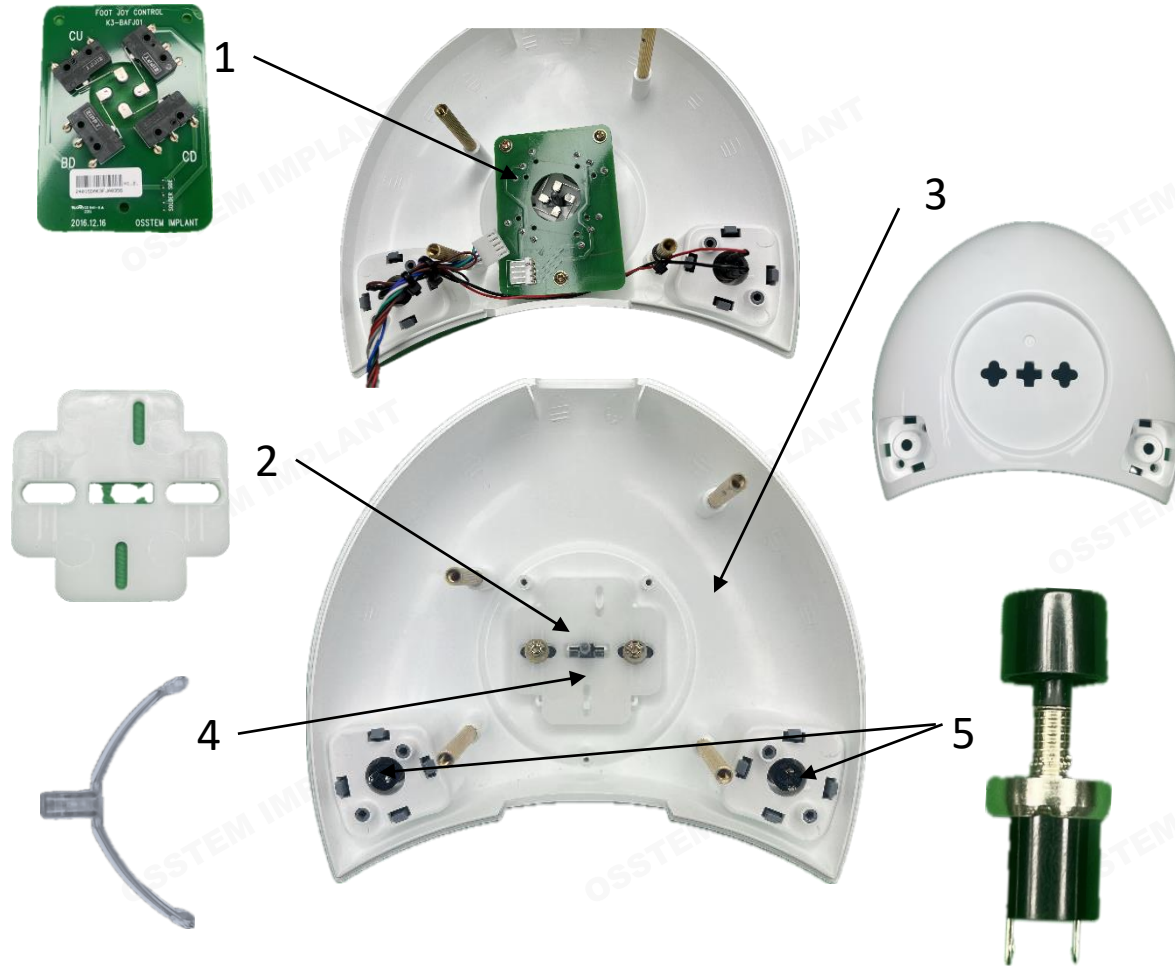

Index	Part code	Part name	Remark
1	YK3FTJP01	FOOT JOYSTICK PCB	
2	YK3FC0011	K3 FOOT MICRO SENSOR BRK	
3	YK3FTCV02	FOOT-TOP-COVER	
4	YK3LBSP01	LEVER SPRING	4 EA
5	YK3-FC0108	FOOT PUSH BUTTON SWITCH	

(K) Stool



K. Stool

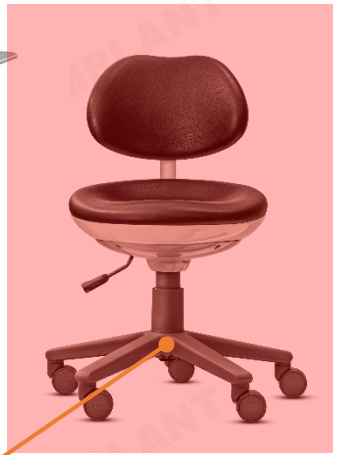

K. Dr Stool – K1



Index	Part code	Part name	Remark
1	YK3DSBS01	STOOL BACK SEAT ASS'Y	Select color
2	YK3DLSL01	STOOL LOWER SEAT ASS'Y	Select color
3	YK3STTC01	SEAT TOP COVER	
4	YK3STBT01	K3 DR. STOOL SEAT BOTTOM COVER	
5	YATSD01	STOOL CASTER (EL)	
6	YK3STBG03	K3 DR. STOOL LEG (EL)	
7-1	YK3DSCM01	K3 DR. STOOL CYLINDER (560mm)	Long type
7-2	YK3DSCS01	K3 DR. STOOL CYLINDER (520mm)	Short type
8	YK3DSCC01	STOOL CYLINDER CAP	

K. Dr Stool – K2



Index	Part code	Part name	Remark
1	YK3STBC01	STOOL BACK REST COVER	
2-1	YK3STCC01	STOOL BACKREST COVER CAP 1	Index a
2-2	YK3STCC02	STOOL BACKREST COVER CAP 2	Index b
2-3	YK3STCC03	STOOL BACKREST COVER CAP 3	Index c
2-4	YK3STCC04	STOOL BACKREST COVER CAP 4	Index d
3	YK3STNK02	K3 DR. STOOL STOOL TILT (NEW)	

K. Assist Stool – K3



Index	Part code	Part name	Remark
1	YATSA01	ASSIST STOOL ARMREST	
2	YK3DSCL01	STOOL CYLINDER (480mm ~ 635mm)	
3	YK3STBG03	K3 DR. STOOL LEG (EL)	
4	YATSD01	STOOL CASTER (EL)	
5	YATSS02	K3 ASSIST STOOL LOWER SEAT ASS'Y (EL)	select color

Thank you

OSSTEM[®]
IMPLANT